

Atmosphere Conference Round - Column Base Assembly

Tools required

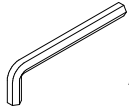

Allen Key (4mm)

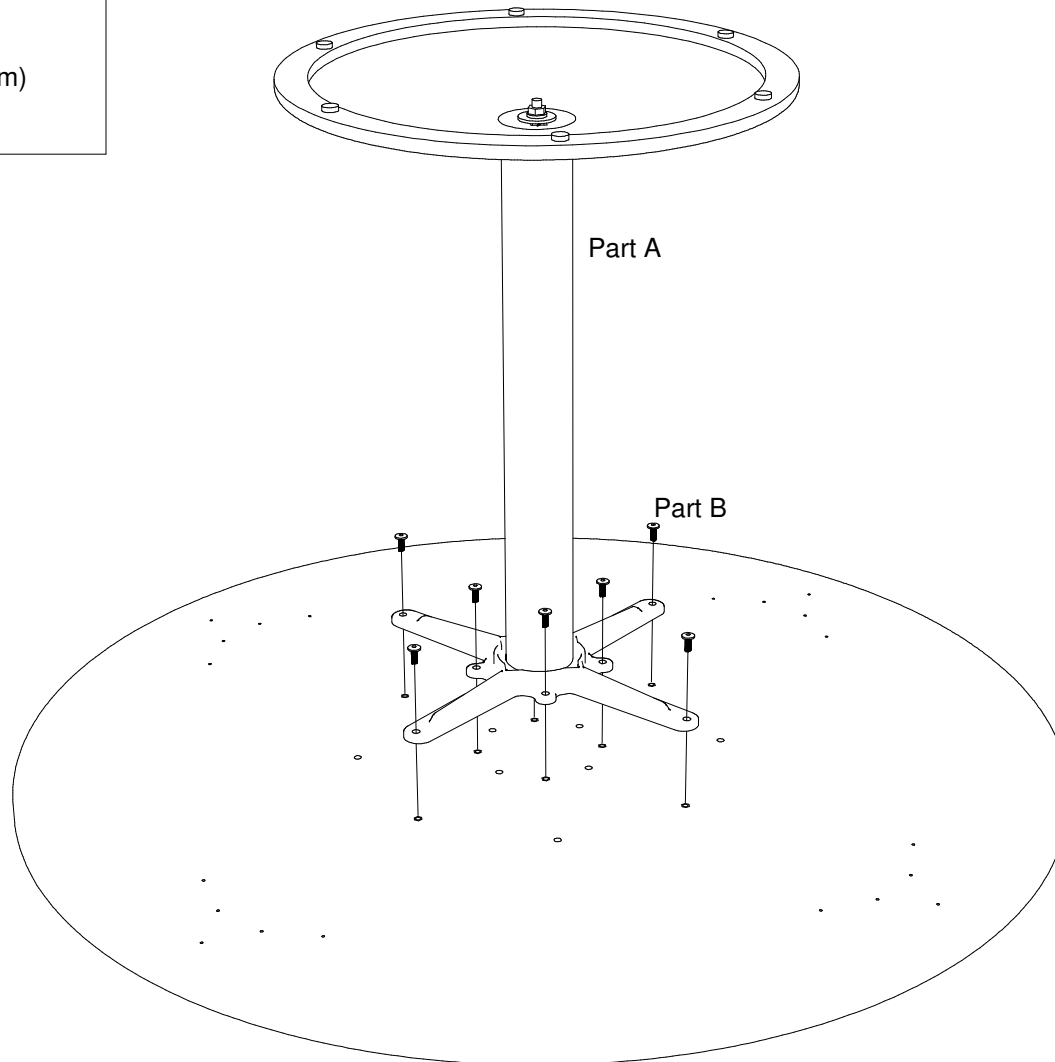

Assembly steps

1. Assemble the column base using the instructions provided in the column pack.
2. Place top upside down on a soft clean surface.
3. Align the column base (part A) to the holes on the underside of the top.
4. Fix the column base to the top using the eight bolts (parts B) as shown.
5. Stand the product onto the base, taking extra care as the column base weighs approximately 23kg.

Parts Supplied

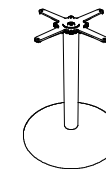

Part A
Column Base
Quantity = 1

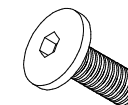

Part B
Bolts
Quantity = 8

Atmosphere Conference Round - Round Leg Assembly

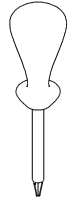

Tools required

Pozi head screw driver

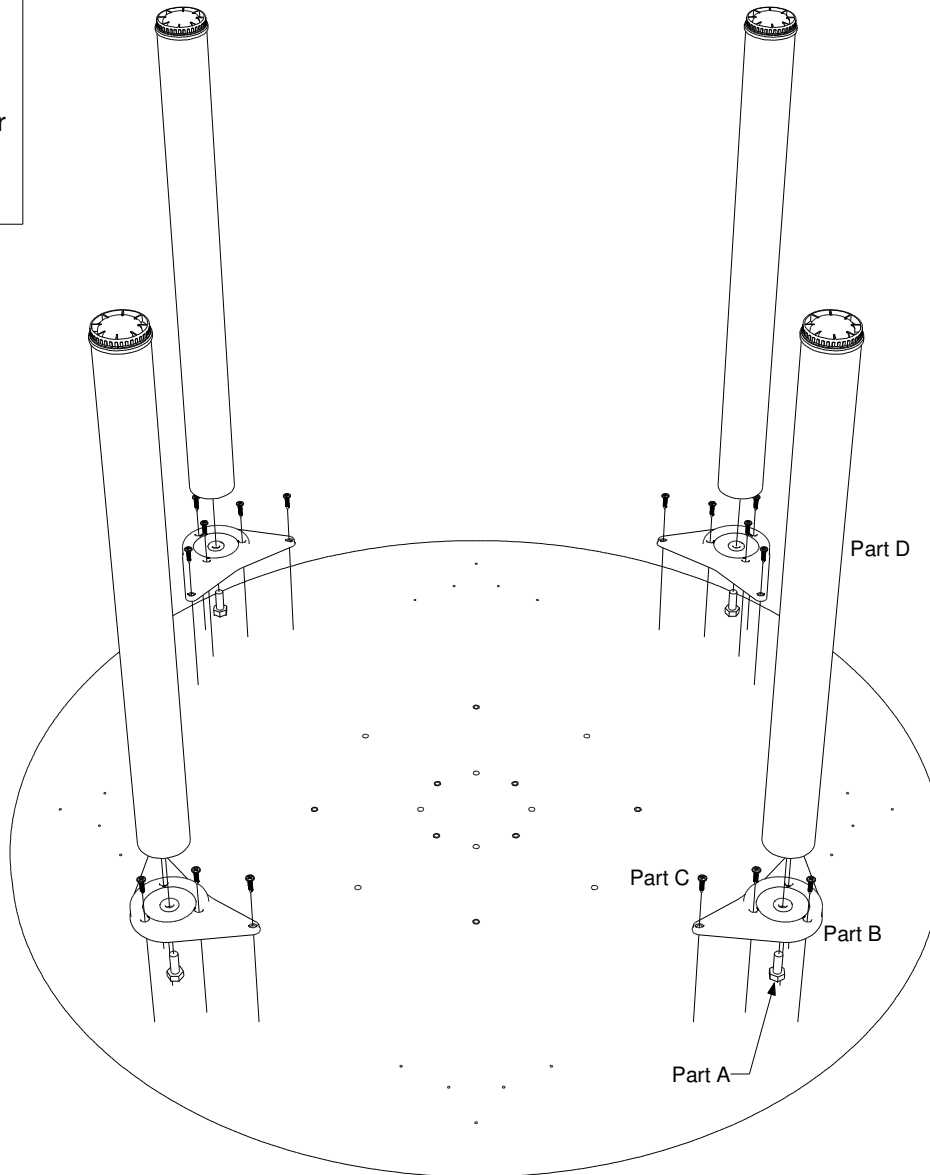

Assembly steps

1. Place top upside down on a soft clean surface.
2. Position the bolts (parts A) in the underside of the leg plates (parts B) as shown.
3. Align the leg plates (parts B) to the holes on the underside of the top.
4. Fix the leg plates to the top using the screws (parts C) as shown.
5. Screw the legs (parts D) on to the leg plates.
6. Stand the product onto the legs.

Parts supplied

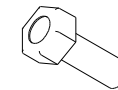

Part A
10mm bolts
Quantity = 4



Part B
Leg plates
Quantity = 4



Part C
Screws
Quantity = 20

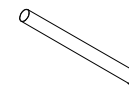

Part D
Legs
Quantity = 4