



LEE & PLUMPTON

Inspiration At Work

FURNITURE COLLECTION

October 2018



ABOUT US

Lee & Plumpton is a family owned and operated British manufacturer of stylish contemporary furniture, established since 1974. We use premium materials sourced from responsible suppliers to create furniture tailored to the demands of the modern commercial interior.



Our product range encompasses everything from desks, storage and boardroom tables to seating and accessories. This means you can source everything you need from a single trusted supplier.

If you need a tailored solution, our Bespoke service offers tailor made solutions transforming your specifications into reality.

T: 01953 453830

E: sales@leeandplumpton.co.uk

W: leeandplumpton.co.uk

BRITISH MANUFACTURERS

All our furniture is designed and manufactured at our 200,000 square foot factory set in 20 acres of land in the East of England.

We are proud to be considered a leading British manufacturer, and to be an established partner to suppliers and specifiers working in all sectors of commercial and contract interiors.



DESIGN
QUALITY
SERVICE



COMMITMENT TO QUALITY

Continuous investment in facilities and training, coupled with a dedicated workforce and strong supplier relationships ensures the quality, consistency and reliability our customers expect.

Every product we manufacture undergoes rigorous quality checks throughout the production process.

Our furniture manufacturing system conforms to the Quality Management Standard BS EN ISO 9001:2015

We offer a 7-year guarantee on all products, unless specified.

OUR PEOPLE

We are a family company who pride ourselves on our quality of product and commitment to client service.

With over 150 employees, we believe that our continued success in delivering excellence relies upon the commitment and integrity of our team. Our people are the foundation of our company values, and we strive to continuously improve our service to you.



JOIN THE CONVERSATION

@LEEANDPLUMPTON

SALES SUPPORT

BESPOKE

With its own production unit and dedicated team, our renowned Bespoke service offers tailor made solutions that will transform your specifications into reality.

Whether it is a simple adjustment to one of our existing ranges, or your own unique scheme, we will deliver to the high standards of quality and finish that define Lee and Plumpton furniture.



We will work closely with you to meet the deadline you need to complete your project.

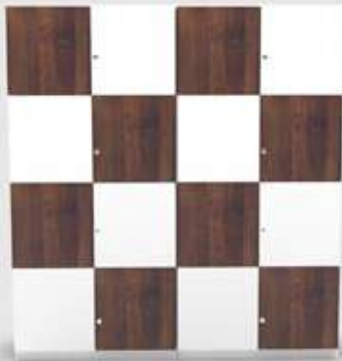

HERE TO HELP

If you are unsure what is possible, your Account Manager or a member of our design team will be happy to assist. For larger projects we can help you to plan, and gain client approval, by providing space planning and visualisation services.

From the simplest to the most complex project our team will support you from idea to delivery.

QUICK & ACCURATE DELIVERY

We will deliver your goods to you with the utmost care.

Rapid order turnaround is guaranteed via our weekly scheduled deliveries and on many items we also offer Quick Ship. Whilst our standard deliveries are free of charge, we also offer next day delivery on stocked items, or customers may collect with 24 hours' notice.



QUICK SHIP

Look out for the Quick Ship logo on selected products. Quick Ship items will be delivered within 5 working days from your order deadline date.



SALES SUPPORT

SPACE PLANNING

Using the latest design technology, our skilled team are able to create space plans to ensure the best layout for your project. We can recommend layouts, and advise which products might be best suited to your needs.

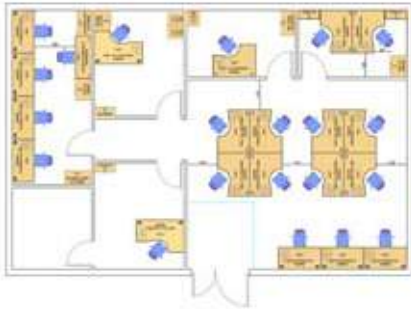

By listening to, and understanding your project requirements, our team will work closely with you to ensure your space plan is a well presented, carefully thought out solution to yours, or your clients' needs.

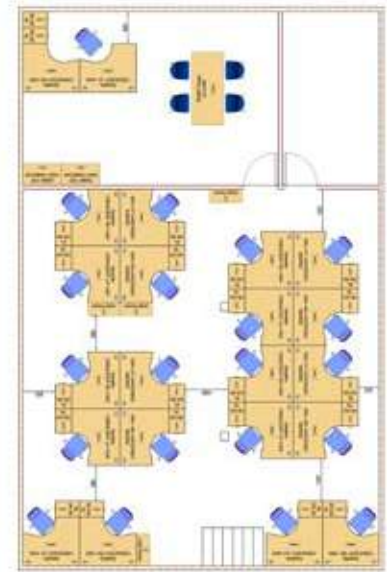

MARKETING LITERATURE PRINT & DIGITAL



Our experienced designers will work closely with you and your Account Manager to help you build your business. We design a wide range of marketing materials and these can be adapted to complement your brand. From flyers, postcards, and posters to a wide range of digital collateral.

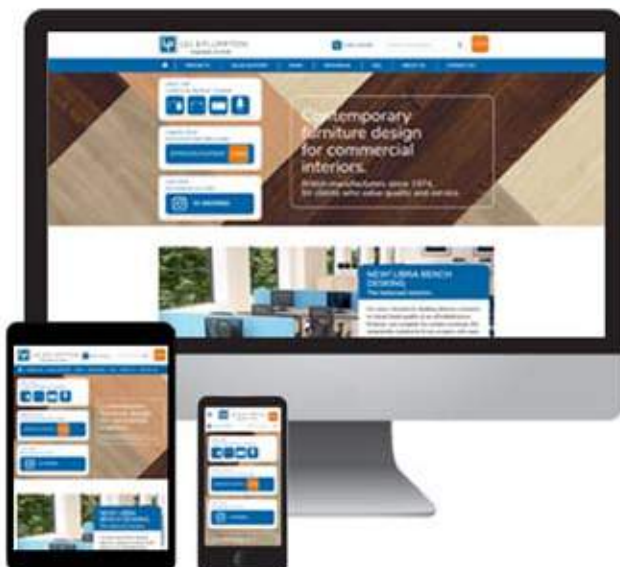

WEBSITE

Visit our website for all the latest resources. As well as detailed 2D and 3D CAD blocks in an ever widening range of file types, we also have an extensive library of product images, assembly instructions, certificates and accreditations.

However if you don't find what you need, please contact your Account Manager or our Customer Services team.

leeandplumpton.co.uk

ASCEND
RECTANGULAR DESK
Page 54

STANDARDS AND CERTIFICATIONS



FM66808

Quality Management System
BS EN ISO 9001:2015 (QMS)



EMS515183

Environmental Management System
BS EN ISO 14001:2015 (EMS)



OHS90285

Occupational Health And Safety
Management System
OHSAS 18001:2007 (OH&S)



British Contract Furnishing
Association (BCFA)



Office Furniture Advisory Service
(OFAS)



Members Of Furniture Industry
Research Association (FIRA)



Furniture Industry Sustainability
Programme (FISP)



Forest Stewardship Council®
TT-COC-003072

Lee & Plumpton desks, tables and workstations comply with BS EN 527-1:2011.
Review our credentials and certifications online at www.leeandplumpton.co.uk

ENVIRONMENTAL RESPONSIBILITY

We recognise our responsibility to consider all aspects of our manufacturing processes in terms of environmental impact. We are committed to continually improving the ways in which we can protect the environment, including the reduction of pollution and waste.

ZERO TO LANDFILL.

Our recovery and recycling initiatives cover 90% of the waste we produce and the remaining 10% is processed as waste to energy (WTE).



BS EN ISO 14001:2015 ENVIRONMENTAL MANAGEMENT SYSTEM

We measure and assess our efforts through our integrated management system by setting clear objectives for improvement, implementing a management programme and conducting regular reviews for continual improvement.



EMS515183

MEMBERS OF (FISP)

We are full members of the Furniture Industry Sustainability Program (FISP) and this enables us to focus on reducing our social and environmental impact.



WASTE MANAGEMENT

The waste that we produce is segregated into individual streams and collected by a waste management company that manages the recycling.

10% is processed as Waste to Energy (WTE).

FOREST STEWARDSHIP COUNCIL® (FSC®)

Our Chain of Custody certification (COC) with the Forest Stewardship Council® (FSC®) represents the unbroken path that certified products take: from the well managed forests of origin to the consumer.

This certification, combined with our efforts to reduce carbon emissions via various recycling initiatives, transportation and our investment in solar power, are all part of our ongoing commitment to work towards a more sustainable and greener future.



The mark of responsible forestry

CONTENTS



DESKING

PAGES 10 – 89

INMOTION NEW	PAGES	10 – 15
AURABENCH	PAGES	16 – 27
LIBRA NEW	PAGES	28 – 33
GEODESK	PAGES	34 – 37
DUTY	PAGES	38 – 47
DOMINOBEAM	PAGES	48 – 53
ASCEND	PAGES	54 – 59
SPIRE	PAGES	60 – 61
SATELLITE	PAGES	62 – 67
ATMOSPHERE	PAGES	68 – 77
GALAXY NEW LINES	PAGES	78 – 81
SMARTTOP	PAGES	82 – 85
RECEPTION	PAGES	86 – 87
SCREENS	PAGES	88 – 89



TABLES

PAGES 90 – 113

SPIRE	PAGES	90 – 95
BARREL & OVAL TABLES	PAGES	96 – 98
DESKING RANGE TABLES	PAGES	99
SLED NEW LINES	PAGES	100 – 101
TILT TOP TABLES	PAGES	102 – 103
FOLDING TABLES	PAGES	104 – 105
DURABLE TABLES	PAGES	106 – 107
ELECT	PAGES	108 – 109
TABLES	PAGES	110 – 113



STORAGE

PAGES 114 – 131

SIGNATURE	PAGES	114 – 123
INFINITY	PAGES	124 – 131



TASK CHAIRS

PAGES 132 – 143

DRAYTON	PAGES	134 – 135
RANWORTH	PAGES	136 – 137
MOULTON	PAGES	138 – 139
SALHOUSE	PAGES	140 – 141
ILOA	PAGES	142 – 143

CONTENTS



CHAIRS & STOOLS

PAGES 144 – 159

ELLINGHAM	PAGES	144
BRANDON	PAGES	145
ASHBY	PAGES	148 – 149
LINGWOOD	PAGES	150 – 152
WROXHAM	PAGES	153
HOLT	PAGES	154
CARBROOKE	PAGES	155
HEYDON	PAGES	156 – 159



SOFT SEATING

PAGES 160 – 177

MOUNT	PAGES	162 – 165
AZUR	PAGES	166 – 167
CAVIL	PAGES	168 – 169
AMITY	PAGES	170 – 171
RAPID	PAGES	172 – 173
DUAL	PAGES	174
STOOLS	PAGES	175
CUSHIONS	PAGES	176 – 177



ACCESSORIES

PAGES 178 – 185

SCREENS	PAGES	178 – 181
PEDESTAL ACCESSORIES	PAGES	182
MONITOR ARMS	PAGES	183
CABLE MANAGEMENT	PAGES	184
CPU HOLDERS	PAGES	185



ADDITIONAL INFORMATION

PAGES 186 – 199

FABRIC GROUPS	PAGES	186 – 191
FABRIC SWATCHES	PAGES	192 – 195
DESK CONFIGURATIONS	PAGES	196 – 199

INMOTION **NEW**

Introducing our fabulous NEW range of sit stand desks. Stylish, ergonomic, and with consistent design details across the whole range, the InMotion will transform your workplace, and your work force.

Whether the simple push button controller, or using the front crank handle, all of our InMotion desks move effortlessly between their lowest and highest settings.



COMPREHENSIVE RANGE

- Electric or Manual.
- Single or Back to Back.
- Choice of four widths.
- Easy to install.
- Silver or White legs.
- Six work top finishes.
- Optional cable management.
- Multiple control options available.

SALHOUSE

TASK CHAIRS

Page 140



QUALITY GUARANTEED

- Manual: Uprights and mechanism 5 year guarantee.
- Electric: Uprights, motor and controller 5 year guarantee.
- All other elements of your InMotion desk 7 year guarantee.



WORK INMOTION

FEEL THE DIFFERENCE

It's not whether you sit or stand,
it's all about being InMotion

We all know that to make a difference to our general health and wellbeing we need to keep moving. With a sit stand desk even 10 minutes of standing will bring benefits to your day, but aiming for 20-30 minutes in every hour is a great target to reach.

Varying your posture can increase blood circulation leading to improvements in concentration and productivity.



Increase Focus

Reduce Stress

Maintain Healthy Joints



The InMotion desk complements an **active lifestyle** to improve your overall health



Keep moving with an InMotion desk.



20/2 rule – every 20 minutes take an active break for 2 minutes.



Exercise for at least 150 minutes a week.

ILOA STOOLS

See **page 142** for our Iloa stool, the perfect flexible companion for InMotion



SIT UP

Correct posture is as important as movement. See **page 132** for our full range of ergonomic task chairs.



INMOTION ELECTRIC

An ideal solution to bring wellbeing to the workplace, our InMotion sit stand desks come in single or back to back versions to make the most of your project space. Whether a full installation, or to complement existing furniture, InMotion will add style and movement.



SALHOUSE
TASK CHAIRS

Page 140

FEATURES & DETAILS

SPECIFICATION

- Worktops 25mm E1 melamine faced high density particle board.
- Weight load capacity (per desk) 80kg.
- Lifting speed of motor 35mm per second.
- Safety – when coming into contact with a solid object, the desk will retract.
- Our InMotion electric sit stand desks conform to **BSI regulation BS – EN 527-1 2011.**
- Cable trays available.

FRAME

- Single and back to back.
- Range of movement from 631mm – 1281mm.

Guarantee

Uprights, motor and controller: 5 year guarantee
All other elements of your InMotion desk: 7 year guarantee

CONTROL PANEL



Four setting memory control panel
Code: SIMCP

CABLE PORTS

- All desks are fitted with cables ports to match the leg. White cable ports with white legs, grey cable ports with silver legs.

SCREENS

- Screens are mounted with either white or silver brackets to match the desk finish.

Screens are available in 4 standard fabric colours:



BK Black **BL** Blue **RB** Ruby **GY** Grey

Alternative colour options available:

Group 1 fabrics: Camira Cara or Carlow range.

Group 2 fabrics: Camira Lucia range.

ORDERING – SCREENS

For standard screen fabrics simply add the colour suffix to your product code. For fabric groups 1 or 2 add the Camira fabric code to your chosen product code.

FEATURES & DETAILS

METAL FINISHES



S Silver **W** White
(L&P White)

WOOD FINISHES



BE Beech **LO** Light Oak **MA** Maple **BI** Birch **WH** White **WA** Walnut

Wood finishes are heat, stain and scratch resistant when used for their intended purposes.

ORDERING

Select the code for the product you require and simply add the metal and wood suffix to your code when ordering.

For example IMRE12D1**ESBI**

Metal: **S** Silver, **W** White | **Wood:** **BE** Beech, **LO** Light Oak, **MA** Maple, **BI** Birch, **WH** White, **WA** Walnut

SINGLE DESK



W x D x H (mm)	Code
1200 x 795 x min:631 max:1281	IMRE12D1E
1400 x 795 x min:631 max:1281	IMRE14D1E
1600 x 795 x min:631 max:1281	IMRE16D1E
1800 x 795 x min:631 max:1281	IMRE18D1E

BACK TO BACK DESK



W x D x H (mm)	Code
1200 x 1680 x min:631 max:1281	IMRE12B2E
1400 x 1680 x min:631 max:1281	IMRE14B2E
1600 x 1680 x min:631 max:1281	IMRE16B2E
1800 x 1680 x min:631 max:1281	IMRE18B2E

SCREENS

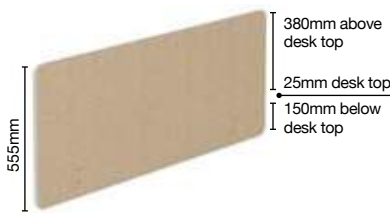

W x H (mm)	Standard colours	Group 1 fabric	Group 2 fabric
1200 x 380	SCIM12W	SCIM12WG1	SCIM12WG2
1400 x 380	SCIM14W	SCIM14WG1	SCIM14WG2
1600 x 380	SCIM16W	SCIM16WG1	SCIM16WG2
1800 x 380	SCIM18W	SCIM18WG1	SCIM18WG2

Table above shows code for screens with white brackets. For silver brackets, replace the 'W' in the code with an 'S'.

CABLE TRAYS



Cable trays are available in silver or white to match the frame finish.

Simply add the colour suffix to your code when ordering. **S** Silver or **W** White.

Desk Width	Cable Trays	Code
1200mm	1 x 400mm and 1 x 600mm	IMCTRAY12
1400mm	2 x 600mm	IMCTRAY14
1600mm	2 x 400mm and 1 x 600mm	IMCTRAY16
1800mm	1 x 400mm and 2 x 600mm	IMCTRAY18

Cable trays are supplied in 400mm and 600mm parts depending on the length of your desk.

INMOTION MANUAL

The front mounted crank handle and manual mechanism makes our InMotion manual sit stand desk a straightforward option to add to any environment.

FEATURES & DETAILS

SPECIFICATION

- Worktops 25mm E1 melamine faced high density particle board.
- Weight load capacity (per desk) 80kg.
- Cable trays available.
- Front mounted crank handle retracts under work surface when not in use.

FRAME

- Single and back to back
- Range of movement from 686mm – 1186mm.

CABLE PORTS

- All desks are fitted with cables ports to match the leg. White cable ports with white legs, grey cable ports with silver legs.

Guarantee

Uprights and mechanism 5 year guarantee
All other elements of your InMotion desk 7 year guarantee



SCREENS

- Screens are mounted with either white or silver brackets to match the desk finish.

Screens are available in 4 standard fabric colours:



BK Black **BL** Blue **RB** Ruby **GY** Grey

Alternative colour options available;

Group 1 fabrics: Camira Cara or Carlow range.

Group 2 fabrics: Camira Lucia range.

ORDERING – SCREENS

For standard screen fabrics simply add the colour suffix to your product code. For fabric groups 1 or 2 add the Camira fabric code to your chosen product code.



Front mounted crank handle retracts under work surface when not in use.

FEATURES & DETAILS

METAL FINISHES



S Silver



W White
(L&P White)

WOOD FINISHES



BE Beech



LO Light Oak



MA Maple



BI Birch

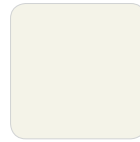

WH White



WA Walnut

Wood finishes are heat, stain and scratch resistant when used for their intended purposes.

ORDERING

Select the code for the product you require and simply add the metal and wood suffix to your code when ordering.

For example IMRE12D1MSBI

Metal: S Silver, W White | **Wood:** BE Beech, LO Light Oak, MA Maple, BI Birch, WH White, WA Walnut

SINGLE DESK



W x D x H (mm)	Code
1200 x 795 x min:686 max:1186	IMRE12D1M
1400 x 795 x min:686 max:1186	IMRE14D1M
1600 x 795 x min:686 max:1186	IMRE16D1M
1800 x 795 x min:686 max:1186	IMRE18D1M

BACK TO BACK DESK



W x D x H (mm)	Code
1200 x 1680 x min:686 max:1186	IMRE12B2M
1400 x 1680 x min:686 max:1186	IMRE14B2M
1600 x 1680 x min:686 max:1186	IMRE16B2M
1800 x 1680 x min:686 max:1186	IMRE18B2M

SCREENS

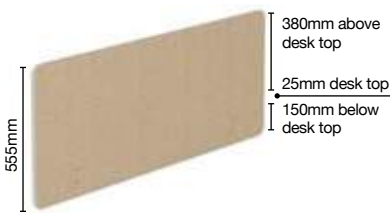

W x H (mm)	Standard colours	Group 1 fabric	Group 2 fabric
1200 x 380	SCIM12W	SCIM12WG1	SCIM12WG2
1400 x 380	SCIM14W	SCIM14WG1	SCIM14WG2
1600 x 380	SCIM16W	SCIM16WG1	SCIM16WG2
1800 x 380	SCIM18W	SCIM18WG1	SCIM18WG2

Table above shows code for screens with white brackets. For silver brackets, replace the 'W' in the code with an 'S'.

CABLE TRAYS



Cable trays are available in silver or white to match the frame finish.

Simply add the colour suffix to your code when ordering. **S** Silver or **W** White.

Desk Width	Cable Trays	Code
1200mm	1 x 400mm and 1 x 600mm	IMCTRAY12
1400mm	2 x 600mm	IMCTRAY14
1600mm	2 x 400mm and 1 x 600mm	IMCTRAY16
1800mm	1 x 400mm and 2 x 600mm	IMCTRAY18

Cable trays are supplied in 400mm and 600mm parts depending on the length of your desk.

AURABENCH

A floating top bench system ideal for collaborative workspaces, or large open plan environments. The AuraBench system offers sleek styling with robust build quality, and the flexibility to grow with your business.

SCREEN
RANGES
From page 178

INVESTMENT QUALITY

- Single desk or 2,4,6,8 bench.
- Plus two retro-fit.
- Easy access high density cable management.
- Table and return desks to complete the installation.

MOULTON
TASK CHAIRS

Page 138

FEATURES & DETAILS

DESK SHAPES

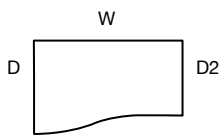

Wave
(Left hand shown)

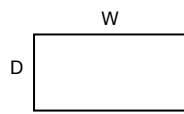

Rectangular

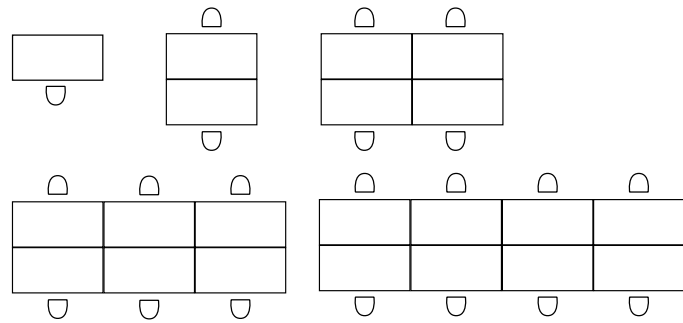

Sets of 2,4,6 and 8. You can also add multiple plus two benches.

METAL FINISHES



S Silver

W White

WOOD FINISHES



BE Beech

LO Light Oak

MA Maple

BI Birch

WH White

WA Walnut

Wood finishes are heat, stain and scratch resistant when used for their intended purposes.

SPECIFICATION

- Floating desktop design made from 25mm grade E1 melamine faced high density particle board.
- The intermediate leg adds extra strength and support.
- Height levelling feet as standard.
- A scallop design is featured at the rear of each desk.

FRAME

- Stylish laser cut profile end frame made from a continuous heavy gauge steel tube for extra strength.

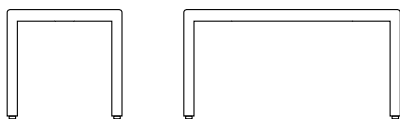

CABLE MANAGEMENT

- All bench systems are supplied with integrated cable management to span the full width of the desk configuration.
- Cable management is angled to provide easy access through the large portholes to cables and power units.
- Additional cable management and accessories are available to purchase separately.

PEDESTAL SPECIFICATION

- 25mm top and drawer fronts with an 18mm unit.
- Narrow pedestal available, 18mm complete unit.
- Silver bow handles.
- Steel options also available.

ORDERING

Select the code for the product you require and simply add the metal and wood suffix to your code when ordering.
For example AUSW14RSBI

Metal: S Silver, W White | **Wood:** BE Beech, LO Light Oak, MA Maple, BI Birch, WH White, WA Walnut

AURABENCH

SINGLE DESK

AVAILABLE IN 600 & 800 DEEP

WAVE DESK



Cable management comes as standard for single desks.

W x D x D2 x H (mm)	Left Hand	Right Hand
600 Deep		
(1200) 1200 x 800 x 600 x 740	AUSW12L	AUSW12R
(1400) 1400 x 800 x 600 x 740	AUSW14L	AUSW14R
(1600) 1600 x 800 x 600 x 740	AUSW16L	AUSW16R
(1800) 1800 x 800 x 600 x 740	AUSW18L	AUSW18R
800 Deep		
(1200) 1200 x 1000 x 800 x 740	AUWV12L	AUWV12R
(1400) 1400 x 1000 x 800 x 740	AUWV14L	AUWV14R
(1600) 1600 x 1000 x 800 x 740	AUWV16L	AUWV16R
(1800) 1800 x 1000 x 800 x 740	AUWV18L	AUWV18R

RECTANGULAR DESK



W x D x H (mm)	Code
600 Deep	
(1200) 1200 x 600 x 740	AURS12
(1400) 1400 x 600 x 740	AURS14
(1600) 1600 x 600 x 740	AURS16
(1800) 1800 x 600 x 740	AURS18
800 Deep	
(1200) 1200 x 800 x 740	AURE12
(1400) 1400 x 800 x 740	AURE14
(1600) 1600 x 800 x 740	AURE16
(1800) 1800 x 800 x 740	AURE18

MODESTY PANEL



Width (mm)	Code
1200 (Width)	AUMO12
1400 (Width)	AUMO14
1600 (Width)	AUMO16
1800 (Width)	AUMO18

Modesty panel fits to the single desk only. 304mm deep, 18mm board with 2mm edging.



AURABENCH

SET OF 2 DESKS

AVAILABLE IN 600 & 800 DEEP

WAVE DESK



Option A



Option B



Option C

W x D x D2 x H (mm)	Option A	Option B	Option C
600 Deep			
(1200) Opt A / Opt B: 1200 x 1400 x 1400 x 740 Opt C: 1200 x 1600 x 1200 x 740	AUSW12S2A	AUSW12S2B	AUSW12S2C
(1400) Opt A / Opt B: 1400 x 1400 x 1400 x 740 Opt C: 1400 x 1600 x 1200 x 740	AUSW14S2A	AUSW14S2B	AUSW14S2C
(1600) Opt A / Opt B: 1600 x 1400 x 1400 x 740 Opt C: 1600 x 1600 x 1200 x 740	AUSW16S2A	AUSW16S2B	AUSW16S2C
(1800) Opt A / Opt B: 1800 x 1400 x 1400 x 740 Opt C: 1800 x 1600 x 1200 x 740	AUSW18S2A	AUSW18S2B	AUSW18S2C
800 Deep			
(1200) Opt A / Opt B: 1200 x 1800 x 1800 x 740 Opt C: 1200 x 2000 x 1600 x 740	AUWV12S2A	AUWV12S2B	AUWV12S2C
(1400) Opt A / Opt B: 1400 x 1800 x 1800 x 740 Opt C: 1400 x 2000 x 1600 x 740	AUWV14S2A	AUWV14S2B	AUWV14S2C
(1600) Opt A / Opt B: 1600 x 1800 x 1800 x 740 Opt C: 1600 x 2000 x 1600 x 740	AUWV16S2A	AUWV16S2B	AUWV16S2C
(1800) Opt A / Opt B: 1800 x 1800 x 1800 x 740 Opt C: 1800 x 2000 x 1600 x 740	AUWV18S2A	AUWV18S2B	AUWV18S2C

RECTANGULAR DESK



W x D x H (mm)	Code
600 Deep	
(1200) 1200 x 1200 x 740	AURS12S2
(1400) 1400 x 1200 x 740	AURS14S2
(1600) 1600 x 1200 x 740	AURS16S2
(1800) 1800 x 1200 x 740	AURS18S2
800 Deep	
(1200) 1200 x 1600 x 740	AURE12S2
(1400) 1400 x 1600 x 740	AURE14S2
(1600) 1600 x 1600 x 740	AURE16S2
(1800) 1800 x 1600 x 740	AURE18S2



SCREENS

We offer a range of desk mounted screens in various colours and formats.
See page 178 for further information.

AURABENCH

SET OF 4 DESKS

AVAILABLE IN 600 & 800 DEEP



WAVE DESK



RECTANGULAR DESK

W x D x D2 x H (mm)	Code
600 Deep	
(1200) 2400 x 1600 x 1200 x 740	AUSW12S4
(1400) 2800 x 1600 x 1200 x 740	AUSW14S4
(1600) 3200 x 1600 x 1200 x 740	AUSW16S4
(1800) 3600 x 1600 x 1200 x 740	AUSW18S4
800 Deep	
(1200) 2400 x 2000 x 1600 x 740	AJWW12S4
(1400) 2800 x 2000 x 1600 x 740	AJWW14S4
(1600) 3200 x 2000 x 1600 x 740	AJWW16S4
(1800) 3600 x 2000 x 1600 x 740	AJWW18S4

W x D x H (mm)	Code
600 Deep	
(1200) 2400 x 1200 x 740	AURS12S4
(1400) 2800 x 1200 x 740	AURS14S4
(1600) 3200 x 1200 x 740	AURS16S4
(1800) 3600 x 1200 x 740	AURS18S4
800 Deep	
(1200) 2400 x 1600 x 740	AURE12S4
(1400) 2800 x 1600 x 740	AURE14S4
(1600) 3200 x 1600 x 740	AURE16S4
(1800) 3600 x 1600 x 740	AURE18S4



MOULTON

TASK CHAIRS

Page 138

AURABENCH

SET OF 6 DESKS

AVAILABLE IN 600 & 800 DEEP

WAVE DESK



Option A



Option B



Option C

W x D x D2 x H (mm)	Option A	Option B	Option C
600 Deep			
(1200) Opt A: 3600 x 1600 x 1200 x 740 Opt B / Opt C: 3600 x 1400 x 1400 x 740	AUSW12S6A	AUSW12S6B	AUSW12S6C
(1400) Opt A: 4200 x 1600 x 1200 x 740 Opt B / Opt C: 4200 x 1400 x 1400 x 740	AUSW14S6A	AUSW14S6B	AUSW14S6C
(1600) Opt A: 4800 x 1600 x 1200 x 740 Opt B / Opt C: 4800 x 1400 x 1400 x 740	AUSW16S6A	AUSW16S6B	AUSW16S6C
(1800) Opt A: 5400 x 1600 x 1200 x 740 Opt B / Opt C: 5400 x 1400 x 1400 x 740	AUSW18S6A	AUSW18S6B	AUSW18S6C
800 Deep			
(1200) Opt A: 3600 x 2000 x 1600 x 740 Opt B / Opt C: 3600 x 1800 x 1800 x 740	AUWV12S6A	AUWV12S6B	AUWV12S6C
(1400) Opt A: 4200 x 2000 x 1600 x 740 Opt B / Opt C: 4200 x 1800 x 1800 x 740	AUWV14S6A	AUWV14S6B	AUWV14S6C
(1600) Opt A: 4800 x 2000 x 1600 x 740 Opt B / Opt C: 4800 x 1800 x 1800 x 740	AUWV16S6A	AUWV16S6B	AUWV16S6C
(1800) Opt A: 5400 x 2000 x 1600 x 740 Opt B / Opt C: 5400 x 1800 x 1800 x 740	AUWV18S6A	AUWV18S6B	AUWV18S6C

RECTANGULAR DESK



W x D x H (mm)	Code
600 Deep	
(1200) 3600 x 1200 x 740	AURS12S6
(1400) 4200 x 1200 x 740	AURS14S6
(1600) 4800 x 1200 x 740	AURS16S6
(1800) 5400 x 1200 x 740	AURS18S6
800 Deep	
(1200) 3600 x 1600 x 740	AURE12S6
(1400) 4200 x 1600 x 740	AURE14S6
(1600) 4800 x 1600 x 740	AURE16S6
(1800) 5400 x 1600 x 740	AURE18S6



ACCESSORIES

Add the finishing touch to your new desk with our range of office accessories.

Turn to page 182 to see the full range.

AURABENCH

SET OF 8 DESKS

AVAILABLE IN 600 & 800 DEEP



WAVE DESK

W x D x D2 x H (mm)	Code
600 Deep	
(1200) 4800 x 1600 x 1200 x 740	AUSW12S8
(1400) 5600 x 1600 x 1200 x 740	AUSW14S8
(1600) 6400 x 1600 x 1200 x 740	AUSW16S8
(1800) 7200 x 1600 x 1200 x 740	AUSW18S8
800 Deep	
(1200) 4800 x 2000 x 1600 x 740	AUWW12S8
(1400) 5600 x 2000 x 1600 x 740	AUWW14S8
(1600) 6400 x 2000 x 1600 x 740	AUWW16S8
(1800) 7200 x 2000 x 1600 x 740	AUWW18S8



RECTANGULAR DESK

W x D x H (mm)	Code
600 Deep	
(1200) 4800 x 1200 x 740	AURS12S8
(1400) 5600 x 1200 x 740	AURS14S8
(1600) 6400 x 1200 x 740	AURS16S8
(1800) 7200 x 1200 x 740	AURS18S8
800 Deep	
(1200) 4800 x 1600 x 740	AURE12S8
(1400) 5600 x 1600 x 740	AURE14S8
(1600) 6400 x 1600 x 740	AURE16S8
(1800) 7200 x 1600 x 740	AURE18S8



INFINITY
STORAGE
Page 124

MOULTON
TASK CHAIRS
Page 138

AURABENCH

SET OF PLUS 2 DESKS
AVAILABLE IN 600 & 800 DEEP

You can add a **plus 2 desk** to extend any configuration and create a cost effective run of desks.

WAVE DESK



Option A



Option B



Option C

W x D x D2 x H (mm)		Option A	Option B	Option C
600 Deep				
(1200)	Opt A / Opt B: 1200 x 1400 x 1400 x 740 Opt C: 1200 x 1600 x 1200 x 740	AUSW12P2A	AUSW12P2B	AUSW12P2C
(1400)	Opt A / Opt B: 1400 x 1400 x 1400 x 740 Opt C: 1400 x 1600 x 1200 x 740	AUSW14P2A	AUSW14P2B	AUSW14P2C
(1600)	Opt A / Opt B: 1600 x 1400 x 1400 x 740 Opt C: 1600 x 1600 x 1200 x 740	AUSW16P2A	AUSW16P2B	AUSW16P2C
(1800)	Opt A / Opt B: 1800 x 1400 x 1400 x 740 Opt C: 1800 x 1600 x 1200 x 740	AUSW18P2A	AUSW18P2B	AUSW18P2C
800 Deep				
(1200)	Opt A / Opt B: 1200 x 1800 x 1800 x 740 Opt C: 1200 x 2000 x 1600 x 740	AUWV12P2A	AUWV12P2B	AUWV12P2C
(1400)	Opt A / Opt B: 1400 x 1800 x 1800 x 740 Opt C: 1400 x 2000 x 1600 x 740	AUWV14P2A	AUWV14P2B	AUWV14P2C
(1600)	Opt A / Opt B: 1600 x 1800 x 1800 x 740 Opt C: 1600 x 2000 x 1600 x 740	AUWV16P2A	AUWV16P2B	AUWV16P2C
(1800)	Opt A / Opt B: 1800 x 1800 x 1800 x 740 Opt C: 1800 x 2000 x 1600 x 740	AUWV18P2A	AUWV18P2B	AUWV18P2C

RECTANGULAR DESK



W x D x H (mm)	Code
600 Deep	
(1200) 1200 x 1200 x 740	AURS12P2
(1400) 1400 x 1200 x 740	AURS14P2
(1600) 1600 x 1200 x 740	AURS16P2
(1800) 1800 x 1200 x 740	AURS18P2
800 Deep	
(1200) 1200 x 1600 x 740	AURE12P2
(1400) 1400 x 1600 x 740	AURE14P2
(1600) 1600 x 1600 x 740	AURE16P2
(1800) 1800 x 1600 x 740	AURE18P2

AURABENCH

RETURN DESK

Additional workspace can be created with a return desk.



RETURN DESK

W x D x H (mm)	Code
800 x 600 x 740mm	AUDR80
1000 x 600 x 740mm	AUDR10
1200 x 600 x 740mm	AUDR12

TABLES

Our meeting tables have the same stylish floating top and curved frame design as our AuraBench desking range.



TABLES

W x D x H (mm)	Code
1200 x 1200 x 740mm	AUBT12BF
1800 x 1200 x 740mm	AUBT18BF
2400 x 1200 x 740mm	AUBT24BF



TASK CHAIRS

We have a range of task chairs to suit your individual office requirements. **See our full range from page 132.**



INFINITY
STORAGE
Page 124

BRANDON
MEETING CHAIRS
Page 146



AURABENCH

PEDESTALS



Steel Mobile Narrow
3 Drawer



Steel Mobile
3 Drawer



Mobile
2 Drawer



Mobile
3 Drawer



Narrow Under
Desk

Pedestal	W x D x H (mm)	Finishes	2 Drawer	3 Drawer
Steel Mobile Narrow	300 x 570 x 600	Silver	–	AUNP57STD3S
Steel Mobile Narrow	300 x 570 x 600	White	–	AUNP57STD3W
Steel Mobile	420 x 570 x 600	Silver	–	AUMP57STD3S
Steel Mobile	420 x 570 x 600	White	–	AUMP57STD3W
Mobile	430 x 600 x 542	All wood finishes	AUMP60D2	AUMP60D3
Narrow Under Desk *	310 x 555 x 680	All wood finishes	–	STNP60D3

* Narrow under desk not suitable for use with 1200mm desks.

PEDESTAL ACCESSORIES

We offer a selection of pedestal accessories including pen trays and a variety of handle options. **See page 182 for further information.**



Bow Handles



Mosaic
Handles



Matrix
Handles



Oval Handles



Bar Handles

AURABENCH

CABLE MANAGEMENT

AuraBench systems are supplied with integrated cable management to span the full width of the configuration. Additional cable management and accessories are available to purchase separately.

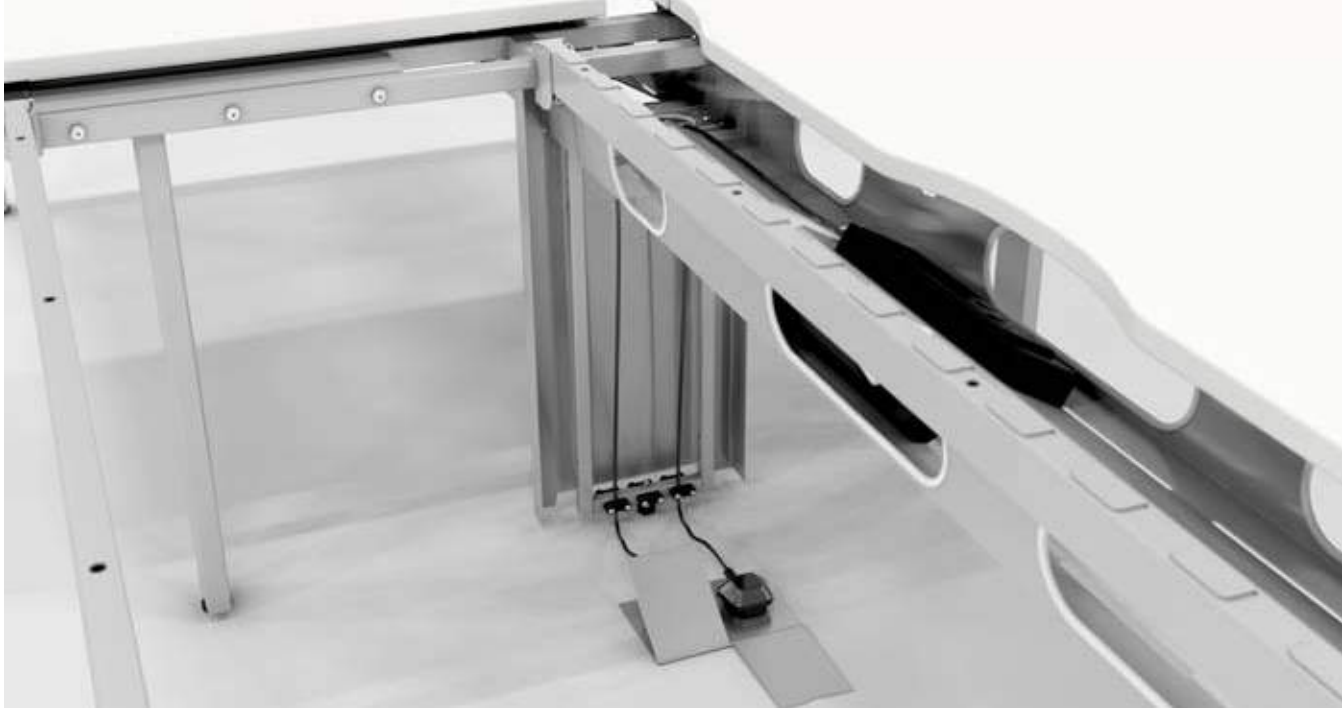

Vertical Cable Tower



Integrated Cable Tray
(comes as standard)



Flat Integrated
Cable Tray



Cable Tray
Linking Unit

Cable Management	Description	Colour	Code
Vertical Cable Tower	Designed to offer complete vertical wire management. To be fitted to any join where integrated horizontal cable management is present. Not suitable for use on the single desk.	Silver, White	AUCTOWERS
Integrated Cable Tray (comes as standard)	Designed to piece together for a perfect result. The integrated cable tray can be connected with the cable tray linking unit and flat cable tray if required. Not suitable for use on the single desk.	Silver, White	
410mm	1 x 410mm and 1 x 610mm cable tray fits a 1200mm desk.		AUCTRAY410S
610mm	2 x 610mm cable trays fit a 1400mm desk.		AUCTRAY610S
810mm	1 x 810mm and 1 x 610mm cable tray fits a 1600mm desk.		AUCTRAY810S
1010mm	1 x 1010mm and 1 x 610mm cable tray fits an 1800mm desk.		AUCTRAY1010S
Flat Integrated Cable Tray, 400mm	The flat integrated cable tray is designed to place large electrical items such as network devices or transformer plugs. Not suitable for use on the single desk.	Silver, White	AUCTRAYF400S
Cable Tray Linking Unit, 180mm (Required to be used with Vertical Cable Tower)	Designed to be positioned above a vertical cable tower to neatly guide the wires through to the cable tower. Not suitable for use on the single desk.	Silver, White	AUCTRAYLINKS

AURABENCH

MONITOR ARMS

Page 183

EXECUTIVE SCREENS

Page 179

Vertical Cable Tower

Designed to offer complete vertical wire management, which can be fitted to group configurations to provide a seamless and integrated solution.

Integrated Cable Tray (comes as standard)

Designed to piece together concealing visible wiring with ease.

LIBRA



On Selected Items

NEW

Ideal for open plan environments, the Libra desk is modular, and scalable to grow and adapt with business needs. Easy to install in busy working environments, the Libra desk delivers a balance of robust build quality at an affordable price.

SALHOUSE
TASK CHAIRS

Page 140

THE BALANCED SOLUTION

- Clean simple lines.
- Robust build quality.
- Desk modesty panels included.
- Easy to install.
- From single desk up to linear sets of 4.
- From double to eight bench desks.
- Optional easy access cable management.



Bench, set of 4 with
Salhouse chairs.
See page 140

FEATURES & DETAILS

METAL FINISHES



S Silver



W White*

WOOD FINISHES



BE Beech*



LO Light Oak



MA Maple



BI Birch

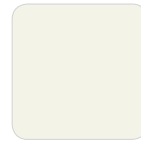

WH White*



WA Walnut

Wood finishes are heat, stain and scratch resistant when used for their intended purposes.



* White legs with Beech or White top is available for Quick Ship Delivery.

SPECIFICATION

- 18mm top made from grade E1 melamine faced high density particle board.
- Modular construction allows additional workstations to be added when required.
- End frames are supplied with an infill panel that matches the colour of the legs.
- Single desks come with a modesty panel as standard.
- Height levelling feet are supplied.

FRAME

- Structural steel frame with an intermediate leg adding strength and stability.

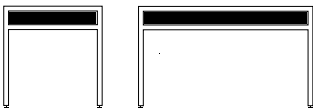

Bench, set of 2



Single desk

CABLE MANAGEMENT

- Cable management trays are available to purchase separately for all desks and benches.

CABLE PORTS

- All desks feature two round cable ports matching the leg colour (white/white, silver/grey).

PEDESTAL SPECIFICATION

- 25mm top with an 18mm unit and drawer fronts. 25kg drawer runners.
- Narrow pedestal (as shown opposite), 18mm complete unit.
- Integral central locking, 2 keys are supplied.
- Silver bow handles.
- Height levelling feet / castors as standard
- Steel pedestal available.

ORDERING

Select the code for the product you require and simply add the metal and wood suffix to your code when ordering. For example LBRE12B4**WWH**

Metal: **S** Silver, **W** White | **Wood:** **BE** Beech, **LO** Light Oak, **MA** Maple, **BI** Birch, **WH** White, **WA** Walnut

LIBRA

LINEAR DESKING

DESK, SINGLE



W x D x H (mm)	Code
1200 x 800 x 740	LBRE12D1
1400 x 800 x 740	LBRE14D1
1600 x 800 x 740	LBRE16D1

DESK, SET OF 2



W x D x H (mm)	Code
(1200) 2400 x 800 x 740	LBRE12D2
(1400) 2800 x 800 x 740	LBRE14D2
(1600) 3200 x 800 x 740	LBRE16D2

DESK, SET OF 3



W x D x H (mm)	Code
(1200) 3600 x 800 x 740	LBRE12D3
(1400) 4200 x 800 x 740	LBRE14D3
(1600) 4800 x 800 x 740	LBRE16D3

DESK, SET OF 4



W x D x H (mm)	Code
(1200) 4800 x 800 x 740	LBRE12D4
(1400) 5600 x 800 x 740	LBRE14D4
(1600) 6400 x 800 x 740	LBRE16D4



SALHOUSE
TASK CHAIRS

Page 140

LIBRA

BENCH DESKING

BENCH, SET OF 2



W x D x H (mm)	Code
(1200) 1200 x 1600 x 740	LBRE12B2
(1400) 1400 x 1600 x 740	LBRE14B2
(1600) 1600 x 1600 x 740	LBRE16B2

BENCH, SET OF 4



W x D x H (mm)	Code
(1200) 2400 x 1600 x 740	LBRE12B4
(1400) 2800 x 1600 x 740	LBRE14B4
(1600) 3200 x 1600 x 740	LBRE16B4

BENCH, SET OF 6



W x D x H (mm)	Code
(1200) 3600 x 1600 x 740	LBRE12B6
(1400) 4200 x 1600 x 740	LBRE14B6
(1600) 4800 x 1600 x 740	LBRE16B6

BENCH, SET OF 8



W x D x H (mm)	Code
(1200) 4800 x 1600 x 740	LBRE12B8
(1400) 5600 x 1600 x 740	LBRE14B8
(1600) 6400 x 1600 x 740	LBRE16B8

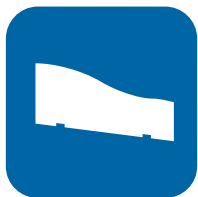

SCREENS

We offer a range of desk mounted screens in various colours and formats.
See page 178 to view the range.



LIBRA

LINEAR DESKING, CONFIGURATIONS

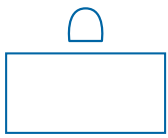

Single

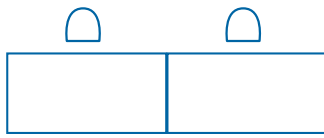

Set of 2

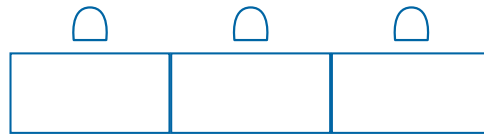

Set of 3

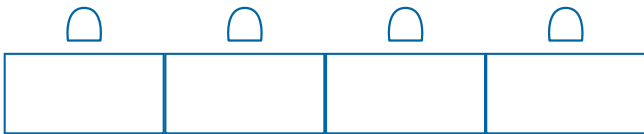

Set of 4

BENCH DESKING, CONFIGURATIONS

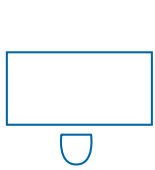

Single

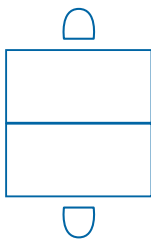

Set of 2

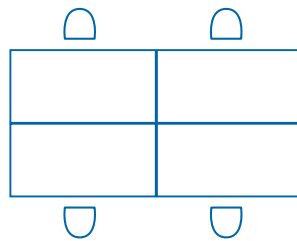

Set of 4

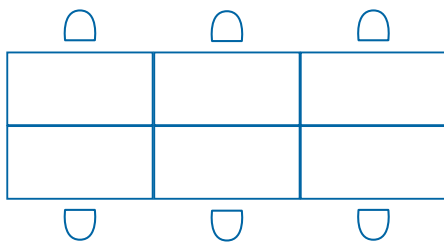

Set of 6

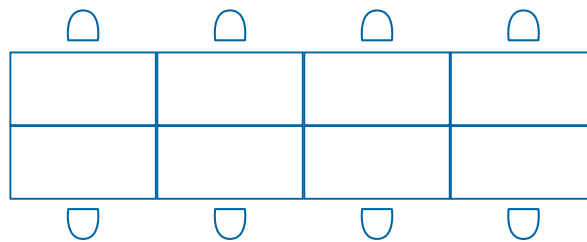

Set of 8

ORDERING

Select the code for the product you require and simply add the metal and wood suffix to your code when ordering.
For example LBRE12B4**WWH**

Metal: **S** Silver, **W** White | **Wood:** **BE** Beech, **LO** Light Oak, **MA** Maple, **BI** Birch, **WH** White, **WA** Walnut

PEDESTALS

Personal storage solutions for the working office.



Steel Mobile Narrow
3 Drawer



Steel Mobile
3 Drawer



Mobile
2 Drawer



Mobile
3 Drawer



Narrow Under Desk
3 Drawer

Pedestal	W x D x H (mm)	Finishes	2 Drawer	3 Drawer
Steel Mobile Narrow	300 x 570 x 600	Silver	–	AUNP57STD3S
Steel Mobile Narrow	300 x 570 x 600	White	–	AUNP57STD3W
Steel Mobile	420 x 570 x 600	Silver	–	AUMP57STD3S
Steel Mobile	420 x 570 x 600	White	–	AUMP57STD3W
Mobile	400 x 600 x 542	All wood finishes	STMP60D2	STMP60D3
Narrow Under Desk	310 x 555 x 680	All wood finishes	–	STNP60D3

PEDESTAL ACCESSORIES

We offer a selection of pedestal accessories including pen trays and a variety of handle options. **See page 182 for further information.**



Bow Handles



Mosaic
Handles



Matrix
Handles



Oval Handles



Bar Handles

CABLE MANAGEMENT

Libra is available with optional cable management, solid metal or wire mesh.

METAL CABLE TRAYS



Description	Colour	Code
Libra 1200 cable tray	Black	LBCTRAY12
Libra 1400 cable tray	Black	LBCTRAY14
Libra 1600 cable tray	Black	LBCTRAY16

WIRE MESH CABLE TRAYS



Description	Colour	Code
Wire mesh cable tray for 1200mm desk	Chrome	ACMESH12
Wire mesh cable tray for 1400mm desk	Chrome	ACMESH14
Wire mesh cable tray for 1600mm desk	Chrome	ACMESH16

GEODESK



GeoDesk is a desking range that combines the functional benefits of a bench system with minimalist style. GeoDesk offers a collaborative workspace for teams of 2 or 4, and it is also perfect for hot-desking.

SCREENS RANGE

From page 178

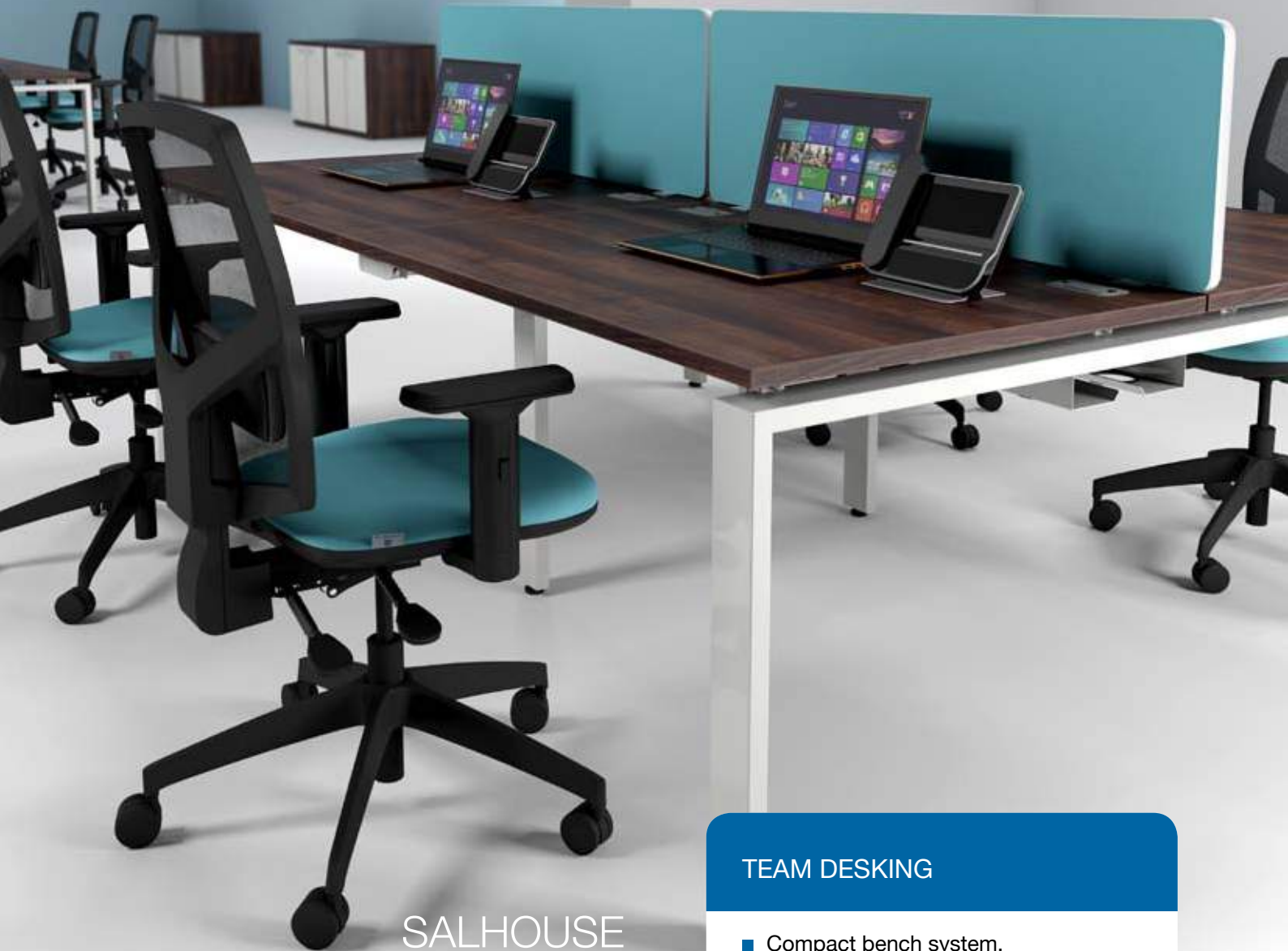

SALHOUSE TASK CHAIRS

Page 140

TEAM DESKING

- Compact bench system.
- Slot in accessible cable management.
- Floating top and sleek styling.

FEATURES & DETAILS

DESK SHAPES

Rectangular

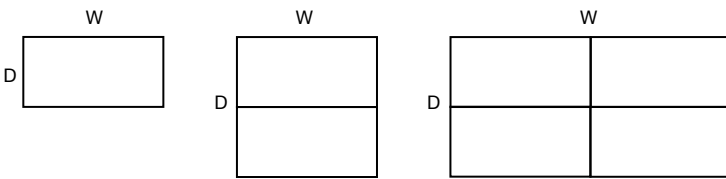

Single desk*

Set of 2 desks

Set of 4 desks

* Single GeoDesk is available on a longer lead time.

METAL FINISHES



W White

WOOD FINISHES



BI Birch

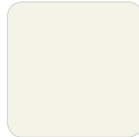

WH White



WA Walnut

Wood finishes are heat, stain and scratch resistant when used for their intended purposes.

SPECIFICATION

- Floating desktop design made from 25mm grade E1 melamine faced high density particle board.
- Modern goalpost bench style leg frame.
- Stylish angular end frame made from heavy gauge steel tube for extra strength.
- The intermediate leg adds further strength and support on sets of 4 desks.
- Height levelling feet.
- Removable cable management trays can be purchased separately.

FRAME

- Goalpost

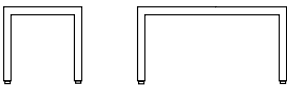

CABLE PORTS

- All desks are fitted with two grey rectangular cable ports. Apart from white desktops which have white cable ports.

PEDESTAL SPECIFICATION

- 25mm top with an 18mm unit and drawer fronts. 25kg drawer runners.
- Narrow pedestal available, 18mm complete unit.
- Integral central locking, 2 keys are supplied.
- Silver bow handles.
- Height levelling feet / castors as standard.
- Steel pedestal available.

ORDERING

Select the code for the product you require and simply add the wood suffix to your code when ordering.

For example GERE12S2BFBI

Wood: BI Birch, WH White, WA Walnut



GEODESK



SINGLE DESK



W x D x H (mm)	Code
1200 x 800 x 740	GERE12S1BF
1400 x 800 x 740	GERE14S1BF
1600 x 800 x 740	GERE16S1BF

SET OF 2 DESKS



W x D x H (mm)	Code
(1200) 1200 x 1605 x 740	GERE12S2BF
(1400) 1400 x 1605 x 740	GERE14S2BF
(1600) 1600 x 1605 x 740	GERE16S2BF

SET OF 4 DESKS



W x D x H (mm)	Code
(1200) 2400 x 1605 x 740	GERE12S4BF
(1400) 2800 x 1605 x 740	GERE14S4BF
(1600) 3200 x 1605 x 740	GERE16S4BF



INFINITY STORAGE
Page 124

AMITY
BOOTHS
Page 171

SALHOUSE
TASK CHAIRS
Page 140

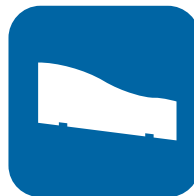

SCREENS

We offer a range of desk mounted screens in various colours and formats. **See page 178 to view the range.**

PEDESTALS

Personal storage solutions for the working office.



Steel Mobile Narrow
3 Drawer



Steel Mobile
3 Drawer



Mobile
2 Drawer



Mobile
3 Drawer



Narrow Under Desk
3 Drawer

Pedestal	W x D x H (mm)	Finishes	2 Drawer	3 Drawer
Steel Mobile Narrow	300 x 570 x 600	Silver	–	AUNP57STD3S
Steel Mobile Narrow	300 x 570 x 600	White	–	AUNP57STD3W
Steel Mobile	420 x 570 x 600	Silver	–	AUMP57STD3S
Steel Mobile	420 x 570 x 600	White	–	AUMP57STD3W
Mobile	400 x 600 x 542	All wood finishes	STMP60D2	STMP60D3
Narrow Under Desk	310 x 555 x 680	All wood finishes	–	STNP60D3

PEDESTAL ACCESSORIES

We offer a selection of pedestal accessories including pen trays and a variety of handle options. **See page 182 for further information.**



CABLE TRAYS

All GeoDesks are available with optional cable management which slots easily into place upon assembly.



W x D x H (mm)	Code
1200 x 134 x 152	GECTRAY12
1400 x 134 x 152	GECTRAY14
1600 x 134 x 152	GECTRAY16



DUTY

Duty has been designed to offer excellence in both form and function. It features a floating desktop design with your choice of a goalpost leg frame or a supporting pedestal.

The optional curved modesty panel sweeps into the supporting pedestal creating a distinctive contrast colour finish. Stylish from all angles, the desk sits well in both open plan and public facing areas.

MOUNT
2 SEATER SOFAS
Page 164

SALHOUSE
TASK CHAIRS
Page 140

PRACTICAL STYLE

- 360° design.
- Choice of features.
- Wide range of desk formats.
- Adaptable by design.
- Matching meeting points and pedestals.

FEATURES & DETAILS

DESK SHAPES

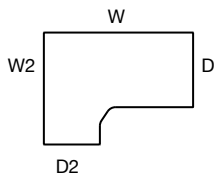

Crescent
(Left hand shown)

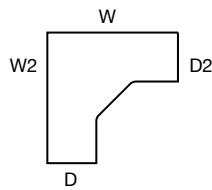

Universal Crescent

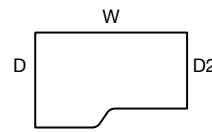

Wave
(Left hand shown)

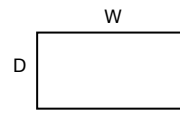

Rectangular

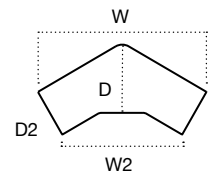

Delta

METAL FINISHES



S Silver

W White

WOOD FINISHES



BE Beech

LO Light Oak

MA Maple

BI Birch

WH White

WA Walnut

Wood finishes are heat, stain and scratch resistant when used for their intended purposes.

SPECIFICATION

- Floating desktop design made from 25mm grade E1 melamine faced high density particle board.
- A strong goalpost frame provides stability.
- A straight modesty panel is available to purchase separately for goalpost and height selectable frames.
- A curved modesty panel is available for pedestal supporting desks.

FRAME OPTIONS

- Goalpost, goalpost height selectable (from 650mm – 850mm) or goalpost with supporting pedestal.

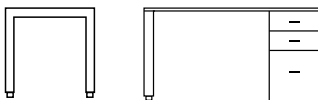

CABLE MANAGEMENT

- Cable management trays are available to purchase separately.

CABLE PORTS

- All desks feature two white round cable ports. Two round cable ports are built into the supporting and 800mm desk high pedestals as part of the cable management system.

PEDESTAL SPECIFICATION

- 25mm top and drawer fronts with an 18mm unit.
- Silver bar handles.
- Mobile under desk pedestals have castors as standard.
- Desk high pedestals have feet as standard.

HEIGHT SELECTABLE LEG

Select the most appropriate and comfortable seating position for individual needs (select height from 650mm – 850mm).



ORDERING

Select the code for the product you require and simply add the metal and wood suffix to your code when ordering. For example DUCR16SFL**WBI**

Metal: **S** Silver, **W** White | **Wood:** **BE** Beech, **LO** Light Oak, **MA** Maple, **BI** Birch, **WH** White, **WA** Walnut

DUTY

GOALPOST & HEIGHT SELECTABLE FRAME

CRESCENT DESK



W x W2 x D x D2 x H (mm)		Standard Frame	Height Selectable
1600 x 1200 x 800 x 600 x 740	Left Hand	DUCR16SFL	DUCR16HSL
1800 x 1200 x 800 x 600 x 740	Left Hand	DUCR18SFL	DUCR18HSL
1600 x 1200 x 800 x 600 x 740	Right Hand	DUCR16SFR	DUCR16HSR
1800 x 1200 x 800 x 600 x 740	Right Hand	DUCR18SFR	DUCR18HSR

UNIVERSAL CRESCENT DESK



W x W2 x D x D2 x H (mm)		Standard Frame	Height Selectable
1400 x 1400 x 600 x 600 x 740		DUUC14SF	DUUC14HS
1600 x 1600 x 600 x 600 x 740		DUUC16SF	DUUC16HS

WAVE DESK



W x D x D2 x H (mm)		Standard Frame	Height Selectable
1400 x 1000 x 800 x 740	Left Hand	DUWV14SFL	DUWV14HSL
1600 x 1000 x 800 x 740	Left Hand	DUWV16SFL	DUWV16HSL
1800 x 1000 x 800 x 740	Left Hand	DUWV18SFL	DUWV18HSL
1400 x 1000 x 800 x 740	Right Hand	DUWV14SFR	DUWV14HSR
1600 x 1000 x 800 x 740	Right Hand	DUWV16SFR	DUWV16HSR
1800 x 1000 x 800 x 740	Right Hand	DUWV18SFR	DUWV18HSR



DUTY

GOALPOST & HEIGHT SELECTABLE FRAME

RECTANGULAR DESK



W x D x H (mm)	Standard Frame	Height Selectable
600 Deep		
1000 x 600 x 740	DURS10SF	DURS10HS
1200 x 600 x 740	DURS12SF	DURS12HS
800 Deep		
1200 x 800 x 740	DURE12SF	DURE12HS
1400 x 800 x 740	DURE14SF	DURE14HS
1600 x 800 x 740	DURE16SF	DURE16HS
1800 x 800 x 740	DURE18SF	DURE18HS

DELTA DESK



W x W2 x D x D2 x H (mm)	Standard Frame	Height Selectable
2079 x 1094 x 830 x 600 x 740	DUDL12SF	DUDL12HS

SUPPORTING PEDESTAL, NO MODESTY

WAVE DESK



W x D x D2 x H (mm)		2 Drawer	3 Drawer
1400 x 1000 x 800 x 740	Left Hand	DUWV14PSL2	DUWV14PSL3
1600 x 1000 x 800 x 740	Left Hand	DUWV16PSL2	DUWV16PSL3
1800 x 1000 x 800 x 740	Left Hand	DUWV18PSL2	DUWV18PSL3
1400 x 1000 x 800 x 740	Right Hand	DUWV14PSR2	DUWV14PSR3
1600 x 1000 x 800 x 740	Right Hand	DUWV16PSR2	DUWV16PSR3
1800 x 1000 x 800 x 740	Right Hand	DUWV18PSR2	DUWV18PSR3

RECTANGULAR DESK



W x D x H (mm)		2 Drawer	3 Drawer
1400 x 800 x 740	Left Hand	DURE14PSL2	DURE14PSL3
1600 x 800 x 740	Left Hand	DURE16PSL2	DURE16PSL3
1800 x 800 x 740	Left Hand	DURE18PSL2	DURE18PSL3
1400 x 800 x 740	Right Hand	DURE14PSR2	DURE14PSR3
1600 x 800 x 740	Right Hand	DURE16PSR2	DURE16PSR3
1800 x 800 x 740	Right Hand	DURE18PSR2	DURE18PSR3

DUTY

SUPPORTING PEDESTAL, WITH MODESTY

WAVE DESK



Left hand shown

W x D x D2 x H (mm)		2 Drawer	3 Drawer
1400 x 1000 x 800 x 740	Left Hand	DUWV14PSML2	DUWV14PSML3
1600 x 1000 x 800 x 740	Left Hand	DUWV16PSML2	DUWV16PSML3
1800 x 1000 x 800 x 740	Left Hand	DUWV18PSML2	DUWV18PSML3
1400 x 1000 x 800 x 740	Right Hand	DUWV14PSMR2	DUWV14PSMR3
1600 x 1000 x 800 x 740	Right Hand	DUWV16PSMR2	DUWV16PSMR3
1800 x 1000 x 800 x 740	Right Hand	DUWV18PSMR2	DUWV18PSMR3

RECTANGULAR DESK



Left hand shown

W x D x H (mm)		2 Drawer	3 Drawer
1400 x 800 x 740	Left Hand	DURE14PSML2	DURE14PSML3
1600 x 800 x 740	Left Hand	DURE16PSML2	DURE16PSML3
1800 x 800 x 740	Left Hand	DURE18PSML2	DURE18PSML3
1400 x 800 x 740	Right Hand	DURE14PSMR2	DURE14PSMR3
1600 x 800 x 740	Right Hand	DURE16PSMR2	DURE16PSMR3
1800 x 800 x 740	Right Hand	DURE18PSMR2	DURE18PSMR3



MOULTON
TASK CHAIRS

Page 138

DUTY

PEDESTALS

Desk high 800mm deep pedestals feature twin cable ports for effective cable management, concealing unsightly wires to provide a clean, finished look.



Mobile Under Desk 2 Drawer Mobile Under Desk 3 Drawer Desk High 600 Deep 2 Drawer Desk High 600 Deep 3 Drawer Desk High 800 Deep 2 Drawer Desk High 800 Deep 3 Drawer

Pedestal	W x D x H (mm)	2 Drawer	3 Drawer
Desk High 600 D	398 x 600 x 740	DUDP60D2	DUDP60D3
Desk High 800 D	398 x 800 x 740	DUDP80D2	DUDP80D3
Mobile Under Desk	398 x 600 x 675	DUMP60D2	DUMP60D3

Mobile under desk pedestals have castors as standard. Desk high pedestals have feet as standard.

PEDESTAL ACCESSORIES

We offer a selection of pedestal accessories including pen trays and a variety of handle options. **See page 182 for further information.**



MEETING POINTS

Duty D-End meeting points create additional workspace for impromptu meetings and collaborative working.

Please note: Meeting points for pedestal supporting desks will require a different bracket. Please contact our friendly Customer Services team for enquiries.



D-End 800mm

D-End 1200mm

D-End 1600mm

Meeting Point	W x D x H (mm)		Code
D-End	800 x 800 x 740	Fits to 1 x 800mm desk	DUMD80
D-End	1200 x 600 x 740	Fits to 2 x 600mm desk	DUMD12
D-End	1600 x 600 x 740	Fits to 2 x 800mm desk	DUMD16

DUTY

MODESTY PANELS

Additional straight modesty panels are available.

MODESTY PANEL



2 modesty panels are required for crescent and universal crescent desks.

Width (mm)	Code
Crescent, Universal Crescent, Wave and Rectangular Desks	
800 (Width)	DU80SM
1000 (Width)	DU10SM
1200 (Width)	DU12SM
1400 (Width)	DU14SM
1600 (Width)	DU16SM
1800 (Width)	DU18SM
Delta Desk	
1200 (Width)	DU12DM

CABLE MANAGEMENT

Cable trays are available in white or silver.

CABLE TRAYS



Silver Cable Tray



White Cable Tray

W x D x H (mm)	Discription	White	Silver
363 x 124 x 62	Fits 1000mm Desk	DUCTRAY10W	DUCTRAY10S
563 x 124 x 62	Fits 1200mm Desk	DUCTRAY12W	DUCTRAY12S
763 x 124 x 62	Fits 1400mm Desk	DUCTRAY14W	DUCTRAY14S
963 x 124 x 62	Fits 1600mm Desk	DUCTRAY16W	DUCTRAY16S
1163 x 124 x 62	Fits 1800mm Desk	DUCTRAY18W	DUCTRAY18S

MAGNETIC CABLE RISER



Discription	White	Silver
Magnetic Cable Riser	DUCAW	DUCAS



A magnetic cable riser is available for desks in the Duty range for quick, effective cable management.

DUTY

STANDARD SCREENS

Compatible with Duty goalpost and goalpost height selectable frames.

Standard screens are available in a choice of 4 standard fabric colours:



ORDERING – STANDARD

Select the code for the product you require and simply add the colour suffix to your code when ordering.

For example SCDS8RBK
BK Black, **RB** Ruby, **BL** Blue, **GY** Grey

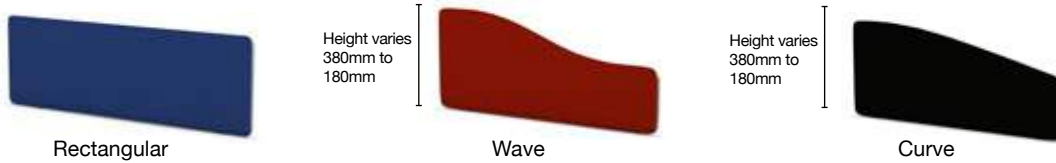

W x H (mm)	Description	Rectangular	Wave	Curve
600 x 380	Fits to 600mm wide desk return	SCDS60R	SCDS60W	SCDS60A
800 x 380	Fits to 800mm wide desk return	SCDS80R	SCDS80W	SCDS80A
1000 x 380	Fits to 1000mm wide desk or desk return	SCDS10R	SCDS10W	SCDS10A
1200 x 380	Fits to 1200mm wide desk or desk return	SCDS12R	SCDS12W	SCDS12A
1400 x 380	Fits to 1400mm wide desk	SCDS14R	SCDS14W	SCDS14A
1600 x 380	Fits to 1600mm wide desk	SCDS16R	SCDS16W	SCDS16A
1800 x 380	Fits to 1800mm wide desk	SCDS18R	SCDS18W	SCDS18A

Alternative colours are available from the Camira Cara, Carlow or Lucia range.

Fabrics: Group 1 fabrics from the Camira Cara or Carlow range.
 Group 2 fabrics from the Camira Lucia range.



For colour fabric swatches refer to page 194.
 For more colour options visit
www.camirafabrics.com/contract

ORDERING – FABRIC GROUPS

Select the code for the product you require and simply add the Camira fabric code.

W x H (mm)	Description	Rectangular Group 1	Wave Group 1	Curve Group 1
600 x 380	Fits to 600mm wide desk return	SCDS60RG1	SCDS60WG1	SCDS60AG1
800 x 380	Fits to 800mm wide desk return	SCDS80RG1	SCDS80WG1	SCDS80AG1
1000 x 380	Fits to 1000mm wide desk or desk return	SCDS10RG1	SCDS10WG1	SCDS10AG1
1200 x 380	Fits to 1200mm wide desk or desk return	SCDS12RG1	SCDS12WG1	SCDS12AG1
1400 x 380	Fits to 1400mm wide desk	SCDS14RG1	SCDS14WG1	SCDS14AG1
1600 x 380	Fits to 1600mm wide desk	SCDS16RG1	SCDS16WG1	SCDS16AG1
1800 x 380	Fits to 1800mm wide desk	SCDS18RG1	SCDS18WG1	SCDS18AG1

W x H (mm)	Description	Rectangular Group 2	Wave Group 2	Curve Group 2
600 x 380	Fits to 600mm wide desk return	SCDS60RG2	SCDS60WG2	SCDS60AG2
800 x 380	Fits to 800mm wide desk return	SCDS80RG2	SCDS80WG2	SCDS80AG2
1000 x 380	Fits to 1000mm wide desk or desk return	SCDS10RG2	SCDS10WG2	SCDS10AG2
1200 x 380	Fits to 1200mm wide desk or desk return	SCDS12RG2	SCDS12WG2	SCDS12AG2
1400 x 380	Fits to 1400mm wide desk	SCDS14RG2	SCDS14WG2	SCDS14AG2
1600 x 380	Fits to 1600mm wide desk	SCDS16RG2	SCDS16WG2	SCDS16AG2
1800 x 380	Fits to 1800mm wide desk	SCDS18RG2	SCDS18WG2	SCDS18AG2

DUTY

DUTY STANDARD SCREENS

Compatible with Duty supporting pedestal frame.

Standard screens are available in a choice of 4 standard fabric colours:



BK Black



BL Blue



RB Ruby



GY Grey



Standard fabrics

ORDERING – STANDARD

Select the code for the product you require and simply add the colour suffix to your code when ordering.

For example SCDP14**RBK**

BK Black, **RB** Ruby, **BL** Blue, **GY** Grey



Rectangular

Height varies
380mm to
180mm

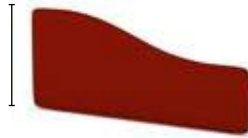

Wave

Height varies
380mm to
180mm



Curve

W x H (mm)	Description	Rectangular	Wave	Curve
1400 x 380	Fits to 1400mm wide desk	SCDP14R	SCDP14W	SCDP14A
1600 x 380	Fits to 1600mm wide desk	SCDP16R	SCDP16W	SCDP16A
1800 x 380	Fits to 1800mm wide desk	SCDP18R	SCDP18W	SCDP18A

Alternative colours are available from the Camira Cara, Carlow or Lucia range.

Fabrics: Group 1 fabrics from the Camira Cara or Carlow range.

Group 2 fabrics from the Camira Lucia range.



For colour fabric swatches refer to page 194.

For more colour options visit

www.camirafabrics.com/contract

ORDERING – FABRIC GROUPS

Select the code for the product you require and simply add the Camira fabric code.

W x H (mm)	Description	Rectangular	Wave	Curve
Group 1 Fabrics				
1400 x 380	Fits to 1400mm wide desk	SCDP14RG1	SCDP14WG1	SCDP14AG1
1600 x 380	Fits to 1600mm wide desk	SCDP16RG1	SCDP16WG1	SCDP16AG1
1800 x 380	Fits to 1800mm wide desk	SCDP18RG1	SCDP18WG1	SCDP18AG1
Group 2 Fabrics				
1400 x 380	Fits to 1400mm wide desk	SCDP14RG2	SCDP14WG2	SCDP14AG2
1600 x 380	Fits to 1600mm wide desk	SCDP16RG2	SCDP16WG2	SCDP16AG2
1800 x 380	Fits to 1800mm wide desk	SCDP18RG2	SCDP18WG2	SCDP18AG2

DUTY

DUTY EXECUTIVE SCREENS

Executive screens are available in a variety of fabric choices, with an option of **(S)** silver or **(W)** white toolrail and matching trim.

Fabrics: Group 1 fabrics from the Camira Cara or Carlow range.
Group 2 fabrics from the Camira Lucia range.

ORDERING – EXECUTIVE

Select the code for the product you require and simply add the Camira fabric code you would like.

To select your toolrail and trim add either **S** Silver or **W** White.



For colour fabric swatches refer to page 194.
For more colour options visit
www.camirafabrics.com/contract

SINGLE / TRIPLE TOOLRAIL



Single Toolrail



Triple Toolrail

W x H (mm)	Description	Single Group 1	Single Group 2	Triple Group 1	Triple Group 2
600 x 380	Fits to 600mm wide desk return	SCDS3T36G1	SCDS3T36G2	SCDS3TR36G1	SCDS3TR36G2
800 x 380	Fits to 800mm wide desk return	SCDS3T38G1	SCDS3T38G2	SCDS3TR38G1	SCDS3TR38G2
1000 x 380	Fits to 1000mm wide desk or desk return	SCDS3T310G1	SCDS3T310G2	SCDS3TR310G1	SCDS3TR310G2
1200 x 380	Fits to 1200mm wide desk	SCDS3T312G1	SCDS3T312G2	SCDS3TR312G1	SCDS3TR312G2
1400 x 380	Fits to 1400mm wide desk	SCDS3T314G1	SCDS3T314G2	SCDS3TR314G1	SCDS3TR314G2
1600 x 380	Fits to 1600mm wide desk	SCDS3T316G1	SCDS3T316G2	SCDS3TR316G1	SCDS3TR316G2
1800 x 380	Fits to 1800mm wide desk	SCDS3T318G1	SCDS3T318G2	SCDS3TR318G1	SCDS3TR318G2



Executive Triple Toolrail
Shown in Cara, Fair Isle

RANWORTH
TASK CHAIRS
Page 136

DOMINOBEAM

DominoBeam provides a complete cable managed solution. The innovative design features a shared leg frame with removable cover plates to conceal cables and wiring.

SALHOUSE
TASK CHAIRS
Page 140

METAL MODESTY
PANEL

Page 53

CABLE MANAGED SOLUTION

- Easy access integrated cable management
- Clean lines, distinctive features
- Plus-one desk option available for larger installations.
- Space and cost efficient add-on option.

FEATURES & DETAILS

DESK SHAPES

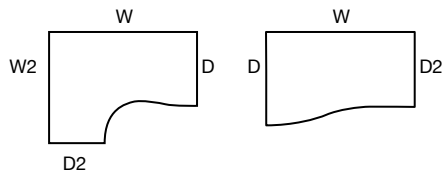

Crescent
(Left hand shown)

Wave
(Left hand shown)

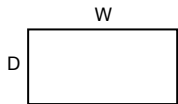

Rectangular



Rectangular desks shown with standard wave screens [page 181](#), and Moulton chairs [page 138](#).

METAL FINISHES



S Silver

W White

WOOD FINISHES



BE Beech

LO Light Oak

MA Maple

BI Birch

WH White

WA Walnut

Wood finishes are heat, stain and scratch resistant when used for their intended purposes.

SPECIFICATION

- 25mm desk top made from grade E1 melamine faced high density particle board.
- A round corner leg features on the crescent desk only.
- Height levelling feet as standard.
- Heavy duty centre rails provide extra rigidity.
- An additional modesty panel is available to purchase separately.

FRAME

- A cable managed beam frame.

CABLE MANAGEMENT

- The beam leg system is supplied with integrated cable trunking.
- The universal leg can be positioned to provide left or right access to the cable management.
- Removable cover plates feature on the inside of each leg allowing the wires to be easily concealed.

CABLE PORTS

- 2 oval silver effect cable ports.

PEDESTAL SPECIFICATION

- 25mm top with an 18mm unit.
- Silver bow handles.

ORDERING

Select the code for the product you require and simply add the metal and wood suffix to your code when ordering.
For example DMCR14LSBI

Metal: S Silver, W White | **Wood:** BE Beech, LO Light Oak, MA Maple, BI Birch, WH White, WA Walnut

DOMINOBEAM

CRESCENT DESK



Crescent Desk



Crescent Plus 1 Desk

W x W2 x D x D2 x H (mm)	Left Hand	Right Hand
1400 x 1200 x 800 x 600 x 725	DMCR14L	DMCR14R
1600 x 1200 x 800 x 600 x 725	DMCR16L	DMCR16R
1800 x 1200 x 800 x 600 x 725	DMCR18L	DMCR18R
Plus 1 Desk		
1400 x 1200 x 800 x 600 x 725	DMCR14P1L	DMCR14P1R
1600 x 1200 x 800 x 600 x 725	DMCR16P1L	DMCR16P1R
1800 x 1200 x 800 x 600 x 725	DMCR18P1L	DMCR18P1R

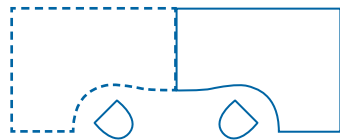

PLUS 1 DESKS
 You can add a plus 1 desk to create additional workspace.



MOULTON
 TASK CHAIRS
 Page 138

PERSONAL
 STORAGE
 Page 53



Metal modesty panel available to purchase separately, see page 53.

Beam Rails: Heavy duty centre rails provide extra rigidity.

Cover Plate: Removable cover plates feature on the inside of each leg allowing the wires to be easily concealed.

DOMINOBEAM

WAVE DESK



Wave Desk



Wave Plus 1 Desk

W x D x D2 x H (mm)	Left Hand	Right Hand
1200 x 1000 x 800 x 725	DMWV12L	DMWV12R
1400 x 1000 x 800 x 725	DMWV14L	DMWV14R
1600 x 1000 x 800 x 725	DMWV16L	DMWV16R
1800 x 1000 x 800 x 725	DMWV18L	DMWV18R
Plus 1 Desk		
1200 x 1000 x 800 x 725	DMWV12P1L	DMWV12P1R
1400 x 1000 x 800 x 725	DMWV14P1L	DMWV14P1R
1600 x 1000 x 800 x 725	DMWV16P1L	DMWV16P1R
1800 x 1000 x 800 x 725	DMWV18P1L	DMWV18P1R

RECTANGULAR DESK



Rectangular Desk



Rectangular Plus 1 Desk

W x D x H (mm)	Code
1200 x 800 x 725	DMRE12
1400 x 800 x 725	DMRE14
1600 x 800 x 725	DMRE16
1800 x 800 x 725	DMRE18
Plus 1 Desk	
1200 x 800 x 725	DMRE12P1
1400 x 800 x 725	DMRE14P1
1600 x 800 x 725	DMRE16P1
1800 x 800 x 725	DMRE18P1

DOMINOBEAM

TABLES

A stylish meeting table to complement the DominoBeam range is available. A plus 1 option to extend the table length is also available upon request.

RECTANGULAR TABLE



Rectangular Table



Rectangular Table, Plus 1 Desk

W x D x H (mm)	Code
1800 x 800 x 725	DMBT18BF
2400 x 800 x 725	DMBT24BF
Plus 1 Table	
1800 x 800 x 725	DMBT18BFP
2400 x 800 x 725	DMBT24BFP



TASK CHAIRS

We have a range of task chairs to suit your individual office requirements.

See our full range from page 132.



CAVIL
ARMCHAIRS
Page 168

BRANDON
MEETING CHAIRS
Page 145

RANWORTH
TASK CHAIRS
Page 136

DOMINOBEAM

MODESTY PANEL



Metal Modesty

Modesty Panel	W x H (mm)		Metal Modesty	Wooden Modesty
Fits Crescent	1200 x 350	Left Hand	DMCRMMP12L	DMCRWMP12L
Fits Crescent	1400 x 350	Left Hand	DMCRMMP14L	DMCRWMP14L
Fits Crescent	1600 x 350	Left Hand	DMCRMMP16L	DMCRWMP16L
Fits Crescent	1800 x 350	Left Hand	DMCRMMP18L	DMCRWMP18L
Fits Crescent	1200 x 350	Right Hand	DMCRMMP12R	DMCRWMP12R
Fits Crescent	1400 x 350	Right Hand	DMCRMMP14R	DMCRWMP14R
Fits Crescent	1600 x 350	Right Hand	DMCRMMP16R	DMCRWMP16R
Fits Crescent	1800 x 350	Right Hand	DMCRMMP18R	DMCRWMP18R
Fits Wave / Rectangular	1200 x 350	–	DMREMMP12	DMREWMP12
Fits Wave / Rectangular	1400 x 350	–	DMREMMP14	DMREWMP14
Fits Wave / Rectangular	1600 x 350	–	DMREMMP16	DMREWMP16
Fits Wave / Rectangular	1800 x 350	–	DMREMMP18	DMREWMP18

2 modesty panels are recommended for crescent desks.

PEDESTALS

Personal storage solutions for the working office.

PEDESTAL ACCESSORIES

We offer a selection of pedestal accessories including pen trays and a variety of handle options, **see page 182 for further information.**



Steel Mobile Narrow
3 Drawer



Steel Mobile
3 Drawer



Mobile
2 Drawer



Mobile
3 Drawer



Desk High, 600 D
3 Drawer



Desk High, 600 D
4 Drawer

Pedestal	W x D x H (mm)	Finishes	2 Drawer	3 Drawer	4 Drawer
Steel Mobile Narrow	300 x 570 x 600	Silver	–	DMSN57ST3S	–
Steel Mobile Narrow	300 x 570 x 600	White	–	DMSN57ST3W	–
Steel Mobile	420 x 570 x 600	Silver	–	DMMP57ST3S	–
Steel Mobile	420 x 570 x 600	White	–	DMMP57ST3W	–
Mobile	430 x 600 x 542	All wood finishes	DMMP60D2	DMMP60D3	–
Desk High, 600 Deep	400 x 600 x 725	All wood finishes	–	DMDP60D3	DMDP60D4
Desk High, 800 Deep	400 x 800 x 725	All wood finishes	–	DMDP80D3	DMDP80D4

Mobile Conversion Kit	Description	Code
	Converts desk high pedestal to mobile	ATMPCONKITS

ASCEND

Ascend brings timeless design to the commercial interior. With a classic A-frame leg that is positioned at a 100° angle, Ascend sets a benchmark for style and elegance.

Pedestals in the range are angled to complement the frame. An optional return can be positioned beneath the desk surface creating a flexible workspace.

In addition, the Ascend tables offer a stylish contemporary solution for breakout and conference areas.



FEATURES & DETAILS

DESK SHAPES

Desk Shapes

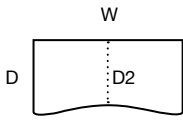

Double Wave

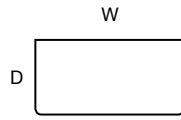

Rectangular

Table Shapes

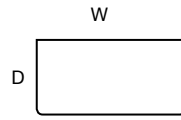

Rectangular

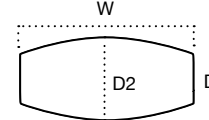

Barrel

METAL FINISHES



W White

WOOD FINISHES



BI Birch

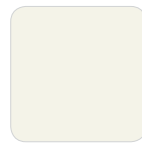

WH White



WA Walnut

Wood finishes are heat, stain and scratch resistant when used for their intended purposes.

DESKS:

Available with white metal frames and modesty panels as standard with a choice of top finish.

TABLES:

Available with white metal frames as standard with a choice of top finish.

PEDESTALS:

Available in white with a choice of wood finish on drawer fronts, desk high units also include matching top as well as drawer fronts. Other top colours are available upon request.

DESK SPECIFICATION

- 25mm desk top made from grade E1 melamine faced high density particle board.
- Metal frame with 1.5mm wall thickness.
- 18mm wooden modesty panel.
- A scallop design is featured at the rear of each desk and the top of the modesty panel.
- Removable cable management trays can be purchased separately.

PEDESTAL SPECIFICATION

- 25mm top and base, all other panels 18mm.

TABLE SPECIFICATION

- 25mm table top made from grade E1 melamine faced high density particle board

ORDERING

Select the code for the product you require and simply add the wood suffix to your code when ordering.

For example ASRE12AFW**BI**

Wood: **BI** Birch, **WH** White, **WA** Walnut

ASCEND

DOUBLE WAVE DESK



W x D x D2 x H (mm)

Code

1200 x 800 x 600 x 740

ASDW12AFW

1400 x 800 x 600 x 740

ASDW14AFW

1600 x 800 x 600 x 740

ASDW16AFW

1800 x 800 x 600 x 740

ASDW18AFW

RECTANGULAR DESK



W x D x H (mm)

Code

1200 x 800 x 740

ASRE12AFW

1400 x 800 x 740

ASRE14AFW

1600 x 800 x 740

ASRE16AFW

1800 x 800 x 740

ASRE18AFW

RETURN DESK



W x D x H (mm)

Code

1000 x 600 x 708

ASDR10AFW

1200 x 600 x 708

ASDR12AFW



MOULTON
TASK CHAIRS

Page 138

RETURN DESKS

Create additional workspace with a return desk.

ASCEND

PEDESTALS

Ascend pedestals are angled to complement the A-frame. Available in white with a choice of wood finish on drawer fronts, desk high units also include matching top as well as drawer fronts. Other top colours are available upon request.



RANWORTH
TASK CHAIRS
Page 136

Under Desk
3 Drawer Pedestals.



Mobile
2 Drawer



Mobile
3 Drawer



Under Desk
2 Drawer



Under Desk
3 Drawer



Desk High
2 Drawer



Desk High
3 Drawer

Pedestals	W x D x H (mm)	2 Drawer	3 Drawer
Mobile	400 x 685 x 598	ASMP68D2	ASMP68D3
Under Desk*	403 x 685 x 709	ASUP68D2	ASUP68D3
Desk High	403 x 800 x 740	ASDP80D2	ASDP80D3

* Please note the under desk pedestal will protrude if placed under a double wave desk. Please ask for details.

PEDESTAL ACCESSORIES

We offer a selection of pedestal accessories including pen trays, **see page 182** for the full range of accessories.

PEN TRAYS



Description	Colour	Code
Single	Dark Grey	ACPTRAY1DG
Pack of 5	Dark Grey	ACPTRAY5

ASCEND

MEETING TABLES

RECTANGULAR TABLE



W x D x H (mm)	Code
1200 x 800 x 740	ASAB12AFW
1600 x 800 x 740	ASAB16AFW
1800 x 800 x 740	ASAB18AFW

BARREL TABLE



W x D x D2 x H (mm)	Code
2500 x 800 x 1000 x 740	ASAB25AFW



BROWSE OUR EXTENSIVE RANGE OF STORAGE SOLUTIONS

Turn to **page 114** to see our Signature storage collection or Infinity range.

SIGNATURE STORAGE

Page 114

LINGWOOD BREAKOUT CHAIRS

Page 150





ASCEND

CABLE TRAYS

Ascend desks are available with optional cable trays.

CABLE TRAYS



W x D x H (mm)	Description	Code
600 x 107 x 60	Fits 1200mm desk	ASCTRAY12
800 x 107 x 60	Fits 1400mm desk	ASCTRAY14
1000 x 107 x 60	Fits 1600mm desk	ASCTRAY16
1200 x 107 x 60	Fits 1800mm desk	ASCTRAY18

MODESTY PANEL DESIGN

The Ascend modesty panel features a scallop design for easy access cable management.



SPIRE

The sleek and distinctive splayed and tapered legs of the Spire desk create a contemporary executive design. Available in a range of finishes to complement any installation, the Spire desk is a distinctive choice for the contemporary workplace.

An extensive range of Spire boardroom and meeting tables are also available (see page xxx)



FEATURES & DETAILS

METAL FINISHES



S Silver

W White



B Matt Black

C Chrome
Paint

WOOD FINISHES



BE Beech

LO Light Oak

MA Maple

BI Birch

WH White

WA Walnut

Wood finishes are heat, stain and scratch resistant when used for their intended purposes.

SPECIFICATION

- 25mm top made from grade E1 melamine faced high density particle board.

FRAME

- Steel frame with hydroformed tapered steel legs and cast aluminium feet.

ORDERING

Select the code for the product you require and simply add the metal and wood suffix to your code when ordering.

For example SPRE1880**CBI**

Metal: **W** White, **B** Matt Black, **S** Silver, **C** Chrome

Wood: **BE** Beech, **LO** Light Oak, **MA** Maple, **BI** Birch, **WH** White, **WA** Walnut

SPIRE

RECTANGULAR DESK



W x D x H (mm)	Code
1800 x 800 x 740	SPRE1880
2000 x 800 x 740	SPRE2080

MODESTY PANEL

In addition, wooden modesty panels are available for Spire desks.

WOODEN MODESTY PANEL



Wooden Modesty Panel	Code	
Fits 800 Deep Rectangular desks	1800 (Width)	SPMO18
Fits 800 Deep Rectangular desks	2000 (Width)	SPMO20

Turn to **page 90** to see our full range of Spire tables.



**RANWORTH
TASK CHAIRS**
Page 136

**SIGNATURE
STORAGE**
Page 114

SATELLITE



Satellite is a versatile range which has been engineered to withstand the demands of the modern office, whilst offering enduring appeal through its simple and practical styling and broad range of options.

CHOICE AND VALUE

- Cantilever or panel ends.
- Range of desk shapes to maximise space.
- Modesty as standard.
- Matching pedestals and meeting points.

PERSPEX
SCREENS
Page 180

MOULTON
TASK CHAIRS
Page 138

FEATURES & DETAILS

DESK SHAPES

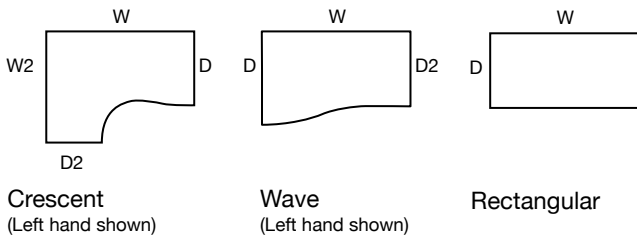

Wave desk shown with a desk high pedestal **page 66**, and Moulton task chair **page 138**.

METAL FINISHES



S Silver

G Grey



W White

WOOD FINISHES



BE Beech

LO Light Oak

MA Maple

BI Birch

WH White

WA Walnut

Wood finishes are heat, stain and scratch resistant when used for their intended purposes.

SPECIFICATION

- 25mm top made from grade E1 melamine faced high density particle board.
- A straight wooden modesty panel (2 panels with a crescent desk) as standard.
- Height levelling feet are supplied.
- A metal corner leg for stability, crescent desk only.

FRAME OPTIONS

- Panel or cantilever.

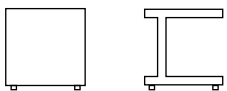

CABLE PORTS

- All desks are fitted with two grey rectangular cable ports. Apart from white desktops which have white cable ports.

PEDESTAL SPECIFICATION

- 25mm top with an 18mm unit and drawer fronts. 25kg drawer runners.
- Narrow pedestal available, 18mm complete unit.
- Integral central locking, 2 keys are supplied.
- Silver bow handles.
- Height levelling feet / castors are supplied.

MEETING POINT SPECIFICATION

- 25mm desk top.
- Round legs.
- Height levelling feet are supplied.

ORDERING

Select the code for the product you require and simply add the metal and wood suffix to your code when ordering.

For example STCR16CLSBI

Metal: S Silver, G Grey, W White | **Wood:** BE Beech, LO Light Oak, MA Maple, BI Birch, WH White, WA Walnut

SATELLITE



CRESCENT DESK PANEL



W x W2 x D x D2 x H (mm)	Left Hand	Right Hand
1400 x 1200 x 800 x 600 x 725	STCR14PL	STCR14PR
1600 x 1200 x 800 x 600 x 725	STCR16PL	STCR16PR
1800 x 1200 x 800 x 600 x 725	STCR18PL	STCR18PR

CRESCENT DESK CANTILEVER



W x W2 x D x D2 x H (mm)	Left Hand	Right Hand
1400 x 1200 x 800 x 600 x 725	STCR14CL	STCR14CR
1600 x 1200 x 800 x 600 x 725	STCR16CL	STCR16CR
1800 x 1200 x 800 x 600 x 725	STCR18CL	STCR18CR

Satellite crescent desks have a metal corner leg for stability, and straight wooden modesty panels.



WAVE DESK PANEL



W x D x D2 x H (mm)	Left Hand	Right Hand
1200 x 1000 x 800 x 725	STWV12PL	STWV12PR
1400 x 1000 x 800 x 725	STWV14PL	STWV14PR
1600 x 1000 x 800 x 725	STWV16PL	STWV16PR

WAVE DESK CANTILEVER



W x D x D2 x H (mm)	Left Hand	Right Hand
1200 x 1000 x 800 x 725	STWV12CL	STWV12CR
1400 x 1000 x 800 x 725	STWV14CL	STWV14CR
1600 x 1000 x 800 x 725	STWV16CL	STWV16CR



SALHOUSE
TASK CHAIRS
Page 140

SATELLITE



RECTANGULAR DESK, PANEL



600 deep rectangular desk must be secured to either a crescent desk or desk high pedestal.

W x D x H (mm)	Code
600 Deep	
800 x 600 x 725	STRS80P
800 Deep	
800 x 800 x 725	STRE80P
1000 x 800 x 725	STRE10P
1200 x 800 x 725	STRE12P
1400 x 800 x 725	STRE14P
1600 x 800 x 725	STRE16P
1800 x 800 x 725	STRE18P

RECTANGULAR DESK, CANTILEVER



600 deep rectangular desk must be secured to either a crescent desk or desk high pedestal.

W x D x H (mm)	Code
600 Deep	
800 x 600 x 725	STRS80C
800 Deep	
800 x 800 x 725	STRE80C
1000 x 800 x 725	STRE10C
1200 x 800 x 725	STRE12C
1400 x 800 x 725	STRE14C
1600 x 800 x 725	STRE16C
1800 x 800 x 725	STRE18C

SATELLITE

PEDESTALS



Personal storage solutions for the working office.



Pedestal	W x D x H (mm)	2 Drawer	3 Drawer	4 Drawer
Narrow Under Desk	310 x 555 x 680	–	STNP60D3	–
Fixed	400 x 585 x 452	STFP58D2	STFP58D3	–
Mobile	400 x 600 x 542	STMP60D2	STMP60D3	–
Desk High, 600 Deep	400 x 600 x 725	–	STDP60D3	STDP60D4
Desk High, 800 Deep	400 x 800 x 725	–	STDP80D3	STDP80D4

PEDESTAL ACCESSORIES

We offer a selection of pedestal accessories including pen trays and a variety of handle options, **see page 182 for further information.**



CABLE MANAGEMENT

Don't let untidy cables tarnish the appearance of your workspace.

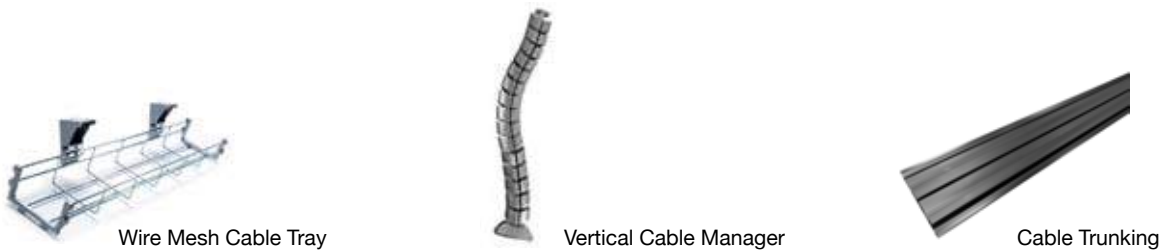

Cable Option	Description	Colour	Code
Wire Mesh Cable Tray	Wire mesh cable tray suitable for 1200mm desk. Additional sizes available, see page 184 for more details. 5 Year Guarantee.	Chrome	ACMESH12
Vertical Cable Manager	V1 Vertical Cable Manager. 5 Year Guarantee.	Black, Silver & White	ACCVSPINE
Cable Trunking	Plastic cable trunking to neatly conceal wires. 2 x 2.5 metre lengths included. Self adhesive to secure to surfaces.	–	ACCTRUNK

SATELLITE



MEETING POINTS

These stylish meeting points create additional workspace for impromptu meetings and collaborative working.



Arc



Square



Shell

Meeting Point	W x D x H (mm)	Finishes	Description	Fits to Panel	Fits to Cantilever
Arc	1200 x 600 x 725	BE, LO, MA	Fits to 2 x 600mm desk	STMA12P	STMA12C
Arc	1600 x 800 x 725	BE, LO, MA	Fits to 2 x 800mm desk	STMA16P	STMA16C
Square	800 x 800 x 725	BE, LO	Fits to 1 x 800mm desk	STSM80PRL	STSM80CRL

Meeting Point	W x D x D2 x H (mm)	Finishes	Description	Fits to Panel	Fits to Cantilever
Shell	1200 x 1200 x 800 x 725	BE, LO, MA	Fits to 1 x 800mm desk	STMS12P	STMS12C

Other colour finishes are available through our Bespoke Service.



SALHOUSE

TASK CHAIRS

Page 140

ATMOSPHERE

Our largest single furniture range, Atmosphere is available in a selection of shapes including crescent conference and delta. Adaptable from a small installation to a large multi-function workspace.

WORKING FOR YOU

- Panel or cantilever leg.
- Optional leg styling choices.
- Seven worktop shapes.
- Selection of meeting points and links.



RANWORTH
TASK CHAIRS
Page 136

MEETING
TABLES

Page 110

FEATURES & DETAILS

DESK SHAPES

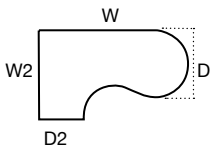

Crescent Conference
(Left hand shown)

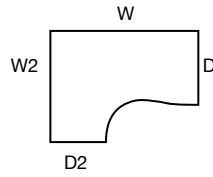

Crescent
(Left hand shown)

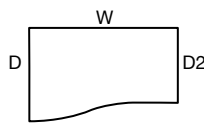

Wave
(Left hand shown)

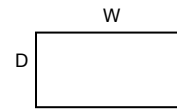

Rectangular

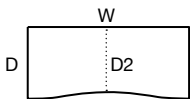

Double Wave

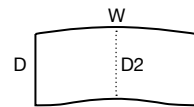

Double Wave Bow

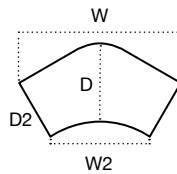

Delta

METAL FINISHES



S Silver **W** White

WOOD FINISHES



BE Beech **LO** Light Oak **MA** Maple **BI** Birch **WH** White **WA** Walnut

Wood finishes are heat, stain and scratch resistant when used for their intended purposes.

DESK SPECIFICATION

- 25mm desk top made from grade E1 melamine faced high density particle board.
- 18mm modesty panels.

FRAME OPTIONS

- Desks are available with a panel or cantilever frame, with a choice of modesty and leg options.
- Wooden modesty panels are available with a straight and curved design, we also offer a straight metal modesty panel.
- Cantilever frames offer a selection of different leg options: metal infill, metal overfill, wooden infill or no infill.

CABLE PORTS

- All desks are supplied with two round, silver coloured cable ports.

PEDESTAL SPECIFICATION

- 25mm top and drawer fronts with an 18mm unit.
- Silver bow handles.

MEETING POINT SPECIFICATION

- 25mm desk top choice of trumpet base or round legs.

ATMOSPHERE

DESK STYLING

Atmosphere desks are available in a range of 7 different shapes with either panel end or cantilever frames.

You can also choose from a selection of leg styling and modesty panel options.

There are 3 different modesty panels: straight, curved and metal. In addition, there are also four different leg options available for cantilever frames: metal infill, metal overfill, wooden infill or no infill.



Panel End

Metal Infill

Metal Overfill

Wooden Infill

HOW TO ORDER

Atmosphere is a comprehensive range with a number of different configurations and codes. Below, we have broken our product code system down into its component parts to make it easier for you to select the desk you require.

Below is a breakdown of a **Crescent Conference desk, 2000mm**.

ATCC20PSMLBI = Crescent conference desk, 2000mm wide, panel end with a straight modesty, left hand in birch.

ATCC20ISMLSBI = Crescent conference desk, 2000mm wide, cantilever frame metal infill with a straight modesty, left hand with silver metal work and birch wood finish.

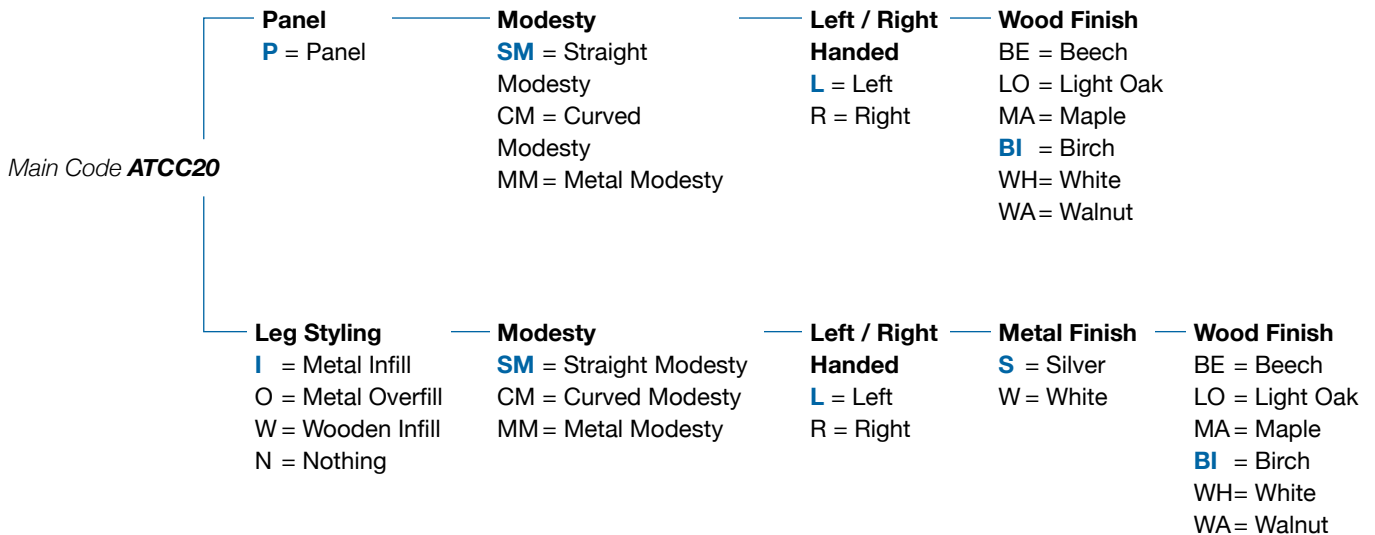

Atmosphere cantilever desks listed in this brochure all feature metal infills with straight modesty panel/s and silver metalwork as standard.

Prices shown are for this desk styling option only.

Prices will vary where different combinations of codes are used.

If you require assistance or clarification, our Customer Services team is here to help on **01953 453830**.

ATMOSPHERE

MODESTY PANEL OPTIONS

Atmosphere desks in this guide are listed with straight modesty panels as standard.

If you would prefer a curved or metal modesty panel, simply alter the partcode as illustrated on **page 70**.



LEG STYLING OPTIONS

Atmosphere cantilever desks in this guide are listed with the metal infill leg styling option as standard.

If you would prefer a metal overfill.

Alter the desk partcode as illustrated on **page 70**.

If you would rather opt for a wooden infill.

Alter the desk partcode as illustrated on **page 70**.

If you don't want any leg styling.

Alter the desk partcode as illustrated on **page 70**.

If you require assistance or clarification, our Customer Services team is here to help on **01953 453830**.

ATMOSPHERE

CRESCENT CONFERENCE, PANEL



W x W2 x D x D2 x H (mm)	Left Hand	Right Hand
2000 x 1200 x 800 x 600 x 725	ATCC20PSML	ATCC20PSMR
2200 x 1200 x 800 x 600 x 725	ATCC22PSML	ATCC22PSMR

CRESCENT CONFERENCE, CANTILEVER



W x W2 x D x D2 x H (mm)	Left Hand	Right Hand
2000 x 1200 x 800 x 600 x 725	ATCC20ISMLS	ATCC20ISMRS
2200 x 1200 x 800 x 600 x 725	ATCC22ISMLS	ATCC22ISMRS

CRESCENT, PANEL



W x W2 x D x D2 x H (mm)	Left Hand	Right Hand
1400 x 1200 x 800 x 600 x 725	ATCR14PSML	ATCR14PSMR
1600 x 1200 x 800 x 600 x 725	ATCR16PSML	ATCR16PSMR
1800 x 1200 x 800 x 600 x 725	ATCR18PSML	ATCR18PSMR

CRESCENT, CANTILEVER



W x W2 x D x D2 x H (mm)	Left Hand	Right Hand
1400 x 1200 x 800 x 600 x 725	ATCR14ISMLS	ATCR14ISMRS
1600 x 1200 x 800 x 600 x 725	ATCR16ISMLS	ATCR16ISMRS
1800 x 1200 x 800 x 600 x 725	ATCR18ISMLS	ATCR18ISMRS

DESK STYLING

Choose from a number of desk styling options. See [page 70](#) for more information.





SALHOUSE
TASK CHAIRS
Page 140

ATMOSPHERE

WAVE, PANEL



W x D x D2 x H (mm)	Left Hand	Right Hand
600 Deep		
1200 x 800 x 600 x 725	ATSW12PSML	ATSW12PSMR
1400 x 800 x 600 x 725	ATSW14PSML	ATSW14PSMR
1600 x 800 x 600 x 725	ATSW16PSML	ATSW16PSMR
800 Deep		
1200 x 1000 x 800 x 725	ATWV12PSML	ATWV12PSMR
1400 x 1000 x 800 x 725	ATWV14PSML	ATWV14PSMR
1600 x 1000 x 800 x 725	ATWV16PSML	ATWV16PSMR
1800 x 1000 x 800 x 725	ATWV18PSML	ATWV18PSMR

WAVE, CANTILEVER



W x D x D2 x H (mm)	Left Hand	Right Hand
600 Deep		
1200 x 800 x 600 x 725	ATSW12ISMLS	ATSW12ISMRS
1400 x 800 x 600 x 725	ATSW14ISMLS	ATSW14ISMRS
1600 x 800 x 600 x 725	ATSW16ISMLS	ATSW16ISMRS
800 Deep		
1200 x 1000 x 800 x 725	ATWV12ISMLS	ATWV12ISMRS
1400 x 1000 x 800 x 725	ATWV14ISMLS	ATWV14ISMRS
1600 x 1000 x 800 x 725	ATWV16ISMLS	ATWV16ISMRS
1800 x 1000 x 800 x 725	ATWV18ISMLS	ATWV18ISMRS

ATMOSPHERE

RECTANGULAR, PANEL



W x D x H (mm)	Code	W x D x H (mm)	Code
600 Deep		800 Deep	
800 x 600 x 725	ATRS80PSM	800 x 800 x 725	ATRE80PSM
1000 x 600 x 725	ATRS10PSM	1000 x 800 x 725	ATRE10PSM
1200 x 600 x 725	ATRS12PSM	1200 x 800 x 725	ATRE12PSM
1400 x 600 x 725	ATRS14PSM	1400 x 800 x 725	ATRE14PSM
1600 x 600 x 725	ATRS16PSM	1600 x 800 x 725	ATRE16PSM
1800 x 600 x 725	ATRS18PSM	1800 x 800 x 725	ATRE18PSM

RECTANGULAR, CANTILEVER



W x D x H (mm)	Code	W x D x H (mm)	Code
600 Deep		800 Deep	
800 x 600 x 725	ATRS80ISM	800 x 800 x 725	ATRE80ISM
1000 x 600 x 725	ATRS10ISM	1000 x 800 x 725	ATRE10ISM
1200 x 600 x 725	ATRS12ISM	1200 x 800 x 725	ATRE12ISM
1400 x 600 x 725	ATRS14ISM	1400 x 800 x 725	ATRE14ISM
1600 x 600 x 725	ATRS16ISM	1600 x 800 x 725	ATRE16ISM
1800 x 600 x 725	ATRS18ISM	1800 x 800 x 725	ATRE18ISM

DOUBLE WAVE, PANEL



W x D x D2 x H (mm)	Code
1600 x 800 x 725 x 725	ATDW16PSM
1800 x 800 x 725 x 725	ATDW18PSM

DOUBLE WAVE, CANTILEVER



W x D x D2 x H (mm)	Code
1600 x 800 x 725 x 725	ATDW16ISMS
1800 x 800 x 725 x 725	ATDW18ISMS

DESK STYLING

Choose from a number of desk styling options. **See page 70 for more information.**

Atmosphere cantilever desks listed in this brochure all feature metal infills with straight modesty panel/s and silver metalwork as standard.

Prices shown are for this desk styling option only.

Prices will vary where different combinations of codes are used.

*If you require assistance or clarification, our Customer Services team is here to help on **01953 453830**.*

ATMOSPHERE

DOUBLE WAVE BOW, PANEL



W x D x D2 x H (mm)	Code
1600 x 875 x 800 x 725	ATWB16PSM
1800 x 875 x 800 x 725	ATWB18PSM
2000 x 875 x 800 x 725	ATWB20PSM

DOUBLE WAVE BOW, CANTILEVER



W x D x D2 x H (mm)	Code
1600 x 875 x 800 x 725	ATWB16ISMS
1800 x 875 x 800 x 725	ATWB18ISMS
2000 x 875 x 800 x 725	ATWB20ISMS

DELTA, PANEL



W x W2 x D x D2 x H (mm)	Code
2076 x 1279 x 1200 x 800 x 725	ATDL12PSM

DELTA, CANTILEVER



W x W2 x D x D2 x H (mm)	Code
2076 x 1279 x 1200 x 800 x 725	ATDL12ISMS



SALHOUSE
TASK CHAIRS

Page 140

ATMOSPHERE

PEDESTALS

PEDESTAL ACCESSORIES

We offer a selection of pedestal accessories including pen trays and a variety of handle options, **see page 182 for further information.**



Mobile
2 Drawer



Mobile
3 Drawer



Under Desk
3 Drawer



Under Desk
4 Drawer



Narrow Under
Desk, 3 Drawer



Desk High
3 Drawer



Desk High
4 Drawer

Pedestal	W x D x H (mm)	2 Drawer	3 Drawer	4 Drawer
Mobile	430 x 600 x 545	ATMP60D2	ATMP60D3	–
Under Desk	430 x 600 x 665	–	ATUP60D3	ATUP60D4
Narrow Under Desk	342 x 600 x 665	–	ATNP60D3	–
Desk High 600 D	430 x 600 x 725	–	ATDP60D3	ATDP60D4
Desk High 800 D	430 x 800 x 725	–	ATDP80D3	ATDP80D4

Mobile Conversion Kit	Description	Code
	Converts desk high pedestal to mobile	ATMPCONKIT

CABLE MANAGEMENT

CABLE TRAYS



All Atmosphere desks are available with optional cable management which slots easily into place upon assembly.

The cable tray can be mounted inside or outside of a modesty panel.

Available in Silver.

Available with or without a socket adaptor.

Description	Code	Description	Code
Crescent		Rectangular	
Return of any desk	ATCTRAY12CRS	800mm	ATCTRAY80RES
1400mm	ATCTRAY14CRS	1000mm	ATCTRAY10RES
1600mm	ATCTRAY16CRS	1200mm	ATCTRAY12RES
1800mm	ATCTRAY18CRS	1400mm	ATCTRAY14RES
Wave		1600mm	ATCTRAY16RES
800mm	ATCTRAY80WVS	1800mm	ATCTRAY18RES
1000mm	ATCTRAY10WVS	Delta	
1200mm	ATCTRAY12WVS	1200mm	ATCTRAY12DLS
1400mm	ATCTRAY14WVS		
1600mm	ATCTRAY16WVS		
1800mm	ATCTRAY18WVS		

VERTICAL CABLE RISER



Description	Colour	Code
Fits to cantilever frame. Attaches inside cantilever frame to conceal cables.	Silver	ATCPLATECCS

ATMOSPHERE

MEETING POINTS

These stylish meeting points create additional workspace for impromptu meetings and collaborative working.



Meeting point Trumpet Base is available in Chrome.

ARC MEETING POINT



Trumpet Base



Round Legs

Meeting Point	W x D x H (mm)	Description	Fits to Panel	Fits to Cantilever
Trumpet Base	1000 x 500 x 725	Fits 1 x 1000mm desks	ATMA10PTBC	ATMA10CTBC
Trumpet Base	1200 x 600 x 725	Fits 2 x 600mm desks	ATMA12PTBC	ATMA12CTBC
Trumpet Base	1600 x 800 x 725	Fits 2 x 800mm desks	ATMA16PTBC	ATMA16CTBC
2 Round Legs	1000 x 500 x 725	Fits 1 x 1000mm desk	ATMA10PRLS	ATMA10CRLS
2 Round Legs	1200 x 600 x 725	Fits 2 x 600mm desks	ATMA12PRLS	ATMA12CRLS
2 Round Legs	1600 x 800 x 725	Fits 2 x 800mm desks	ATMA16PRLS	ATMA16CRLS

BUBBLE MEETING POINT



Trumpet Base



Round Legs

Meeting Point	W x W2 x D x H (mm)	Description	Fits to Panel	Fits to Cantilever
Trumpet Base	600 x 800 x 665 x 725	Fits 1 x 600mm desks	ATMB60PTBC	ATMB60CTBC
Trumpet Base	800 x 1000 x 800 x 725	Fits 1 x 800mm desks	ATMB80PTBC	ATMB80CTBC
2 Round Legs	600 x 800 x 665 x 725	Fits 1 x 600mm desks	ATMB60PRLS	ATMB60CRLS
2 Round Legs	800 x 1000 x 800 x 725	Fits 1 x 800mm desks	ATMB80PRLS	ATMB80CRLS

QUAD MEETING POINT



Trumpet Base



Round Legs

Meeting Point	W x W2 x D x D2 x H (mm)	Description	Fits to Panel	Fits to Cantilever
Trumpet Base	1000 x 1000 x 800 x 800 x 725	Fits 2 x 800mm desks	ATMQ10PTBC	ATMQ10CTBC
Trumpet Base	1200 x 1000 x 800 x 800 x 725	Fits 2 x 800mm desks	ATMQ12PTBC	ATMQ12CTBC
2 Round Legs	1000 x 1000 x 800 x 800 x 725	Fits 2 x 800mm desks	ATMQ10PRLS	ATMQ10CRLS
2 Round Legs	1200 x 1000 x 800 x 800 x 725	Fits 2 x 800mm desks	ATMQ12PRLS	ATMQ12CRLS

90° CURVE, LINK UNIT



Link Unit	W x D x H (mm)	Description	Fits to Panel	Fits to Cantilever
90° Curve	800 x 800 x 725	Joins 2 x 800mm desks at 90°	ATLU80P9D	ATLU80C9D

GALAXY



Back in our main guide by popular demand, the Galaxy desk is an enduring favourite. Now also available in contemporary grey and white, the Galaxy desk is practical, robust, and here to stay.



MOULTON
TASK CHAIRS
Page 138

FEATURES & DETAILS

DESK SHAPES

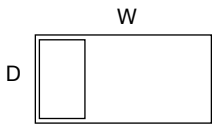

Single Pedestal Desk

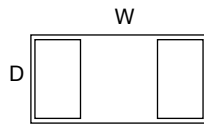

Double Pedestal Desk



METAL FINISHES



G Grey

WOOD FINISHES

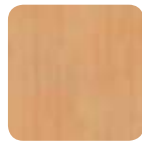

BE Beech



WH White*

NEW

White Now
Quick Ship

* White not available on secretarial return. White 1800mm desks not available on Quick Ship.

Wood finishes are heat, stain and scratch resistant when used for their intended purposes.

SPECIFICATION

- 18mm top made from grade E1 melamine faced high density particle board.
- All desks have the option of single pedestal with left or right hand positioning or double pedestals.
- Pedestals have recessed handles.
- Height levelling feet are supplied.
- Full metal underframe for additional strength.
- A straight wooden modesty panel as standard.

FRAME

- All desks feature 4 metal legs.

PEDESTAL SPECIFICATION

- 25kg, full length metal drawer runners.
- Integral central locking, 2 keys supplied.



SECRETARIAL RETURN SPECIFICATION

- 18mm top made from grade E1 melamine faced high density particle board.
- Five black sliding trays are included.
- Only suitable for fixing to the 1500mm and 1800mm single pedestal desk.
- Can be left or right hand positioned.
- Available in beech only.

ORDERING

Select the code for the product you require and simply add the metal and wood suffix to your code when ordering. For example GARE12SPD2**G****BE**

Metal: **G** Grey | **Wood:** **BE** Beech, **WH** White



GALAXY



SINGLE PEDESTAL DESK

2 DRAWER



W x D x H (mm)	Code
1200 x 745 x 720	GARE12SPD2
1500 x 745 x 720	GARE15SPD2
1800 x 745 x 720	GARE18SPD2

White 1800mm desks not available on Quick Ship.

3 DRAWER



W x D x H (mm)	Code
1200 x 745 x 720	GARE12SPD3
1500 x 745 x 720	GARE15SPD3
1800 x 745 x 720	GARE18SPD3

White 1800mm desks not available on Quick Ship.

DOUBLE PEDESTAL DESK

2 & 3 DRAWER



W x D x H (mm)	Code
1500 x 745 x 720	GARE15DP
1800 x 745 x 720	GARE18DP

White 1800mm desks not available on Quick Ship.

PEDESTAL ACCESSORIES

We offer a selection of pedestal accessories including pen trays, **see page 182** for the full range of accessories.

PEN TRAYS



Description	Colour	Code
Single	Dark Grey	ACPTRAY1DG
Pack of 5	Dark Grey	ACPTRAY5



SECRETARIAL RETURN DESK

SECRETARIAL RETURN



W x D x H (mm)

1050 x 450 x 695

Code

GADR10

*Only suitable for fixing to the 1500mm and 1800mm single pedestal desk.
White finish not available on secretarial return.*



MOULTON
TASK CHAIRS

Page 136

SMARTTOP

The SmartTop desk mechanism quickly folds a monitor, keyboard, and mouse into a secure compartment beneath the desk surface. Perfect for classrooms and training suites, the SmartTop desk delivers flexible facilities and secure storage in one innovative solution.



BRANDON
MEETING CHAIRS
Page 145

FEATURES & DETAILS

METAL FINISHES



S Silver

W White

WOOD FINISHES



BE Beech

MA Maple

WH White

Wood finishes are heat, stain and scratch resistant when used for their intended purposes.

SPECIFICATION

- Lid constructed from 18mm MFC.
- 25mm MDF top provides added durability.
- 18mm MFC modesty panel.
- Double cantilever end frame adds strength and stability.
- Silver or white finish end frame.
- Fully locking secure mechanism.
- Levelling feet as standard.
- Optional single and double CPU stands available.

RECOMMENDATIONS

- Recommended standard flat screen monitor size is between 16-19 inches.
- Weight loading capacity of up to 5kg.

2 year Guarantee on monitor mechanism.



SmartTop single
(Left, right and central hand options)



SmartTop Double
(Left and right hand options)

ORDERING

Select the code for the product you require and simply add the metal and wood suffix to your code when ordering.

For example SMRE96SILSBE

Metal: **S** Silver, **W** White

Wood: **BE** Beech, **MA** Maple, **WH** White

SMARTTOP

SMARTTOP SINGLE (900MM)



Left Hand

Right Hand

W x D x H (mm)		Code
900 x 600 x 725	Left Hand	SMRE96SIL
900 x 600 x 725	Right Hand	SMRE96SIR

SMARTTOP SINGLE, CENTRAL



W x D x H (mm)		Code
1200 x 600 x 725	Central	SMRE12SIC

SMARTTOP DOUBLE (1650MM)



Left Hand

Right Hand

W x D x H (mm)		Code
1650 x 600 x 725	Left Hand	SMRE16DBL
1650 x 600 x 725	Right Hand	SMRE16DBR

SMARTTOP DOUBLE (1800MM)



Left Hand

Right Hand

W x D x H (mm)		Code
1800 x 600 x 725	Left Hand	SMRE18DBL
1800 x 600 x 725	Right Hand	SMRE18DBR

CPU STANDS / HOLDER



Single Stand



Double Stand



CPU Holder L&P 01

CPU Option	Description	Colour	Code
Single Stand	578 x 225 x 62, attaches to bottom of cantilever end frame.	–	STSSSL
Double Stand	578 x 426 x 62, attaches to bottom of cantilever end frame.	–	STDSSL
CPU Holder L&P 01 *	C3 large CPU holder for fixing to desk top, adjustable in W 80 – 220mm, H 300 – 530mm.	Black, Silver & White	ACCPUHOLDL

* Excludes double SmartTop 1650mm desks.



SALHOUSE

TASK CHAIRS

Page 140

The compact SmartTop design provides a secure dual use desk solution.

RECEPTION



Our clean and simple reception unit is a practical solution for any business that requires a welcome desk for visitors. The unit can be left or right handed and we offer additional tables, meeting point, and seating options to complete your reception area.



See our full range of soft seating from pages 160.



MEETING POINTS

Combine our reception unit with a Satellite shell meeting point to create additional space and accessibility.

Page 67

FEATURES & DETAILS

SPECIFICATION

RECEPTION UNIT

- 25mm top made from grade E1 melamine faced high density particle board.
- Full depth, 18mm modesty panels.
- Single grey cable port.
- Pigeon hole system.
- Height levelling feet.

RECEPTION TABLES

- 25mm or 18mm top made from grade E1 melamine faced high density particle board.
- Tables available with square metal legs or cross base.

BESPOKE DESIGN

Our team can work with you to design and manufacture reception furniture which is tailor-made to your requirements.

To find out more call our helpful Customer Services team on

01953 453830 or email sales@leeandplumpton.co.uk





FEATURES & DETAILS

METAL FINISHES



G Grey



B Brown

Brown metal work with Light Oak only.

WOOD FINISHES



BE Beech



LO Light Oak



MA Maple

Wood finishes are heat, stain and scratch resistant when used for their intended purposes.

ORDERING

Select the code for the product you require and simply add the metal and wood suffix to your code when ordering.

For example RUCR18PL**G****B****E**
G**B****E** Grey metal work with Beech

RECEPTION UNIT



Left hand shown

W x W2 x D x D2 x H (mm)

1800 x 1200 x 800 x 600 x 1177

Left Hand

RUCR18PL

Right Hand

RUCR18PR

SQUARE TABLE



Square Legs

W x D x H (mm)

600 x 600 x 385, 18mm Top

Code

TBSR60SQ

ROUND TABLE



Square Legs

W x D x H (mm)

750 x 385, 18mm Top

Code

TBRR75SQ

CROSS BASE TABLE



Panel Base

W x D x H (mm)

600 x 600 x 396, 25mm Top

Code

TBSR60P

800 x 800 x 396, 25mm Top

TBSR80P

For more table options see pages 90 to 113.

SCREENS

Please note: *Duty and InMotion desks require their own screens please refer for Duty pages 45 to 47, InMotion pages 12 to 15.*

Desk mounted screens help to define personal space while adding an attractive splash of colour to your office environment.

EXECUTIVE SCREENS

Executive screens feature a stylish single or triple toolrail in a choice of silver or white with matching trim.

Screens can be linked together where required. The toolrail allows for accessories such as monitor arms.

See **page 183** for our monitor arm range.

Select from 380mm and 480mm heights.

Choose from a variety of colour fabrics from either the **Camira Cara, Carlow or Lucia range. See page 194.**

See **page 179** to view our full range of Executive screens.



PERSPEX SCREENS

Perspex screens provide a modern solution to desk partitions, and are available in 3 shapes; rectangular, wave or curve. Made from 5mm translucent perspex.

Available in a choice of 4 colours: Clear, Frosted White, Green or Blue. Alternative options are available upon request.



Clear

Frosted
White

Green

Blue

See **page 180** to view our full range of Perspex screens.



STANDARD SCREENS

Fully upholstered screens in a choice of fabrics with a PVC trim and 3 shape options rectangular, wave or curve. Screens can be fitted in the centre of a cluster of desks.

Quick Ship Deliveries available on 4 fabric colours: Black, Blue, Ruby Red or Grey.



Black

Blue

Ruby

Grey



Alternative colour options are available from the **Camira Cara, Carlow or Lucia range. See page 194.**

See **page 181** to view our full range of Standard screens.



Executive screens with triple white toolrail shown with single monitors arms.



AURABENCH
WAVE DESK
Page 16

RANWORTH
TASK CHAIRS
Page 136

ACCESSORIES

Whether specifying a new interior or refurbishing an existing work space, accessories are the little extras that make all the difference.

ADJUSTABLE WORKING

Adjust the height of your screens with ergonomic monitor arms, find the best working level for the user, as well as freeing up valuable desktop space.

Monitor arms can be fitted to Executive toolrail screens.

See our full range of monitor arms on [page 183](#).

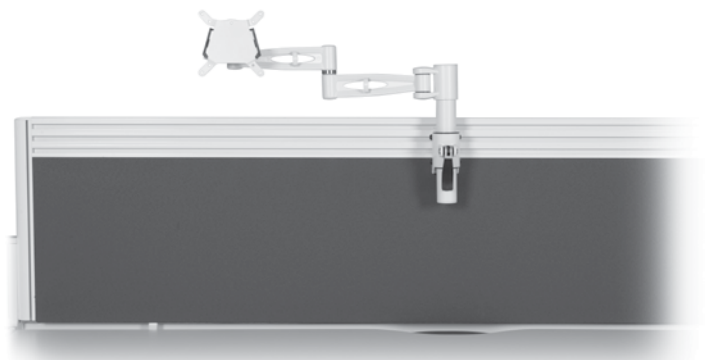

TIDY DESK SPACE

Tidy away cables with our range of cable management, clear away desk top clutter with a drawer tray, or simply give everything a face lift with new matching handles.

See our full range of accessories from [page 182](#).



SPIRE

Complementing our Spire desks, these distinctive tables are ideal for high profile spaces where first impressions count. From a reception area to a corporate boardroom, Spire tables will set the scene with style.



ELLINGHAM
MEETING CHAIRS

Page 144

FEATURES & DETAILS

TABLE SHAPES

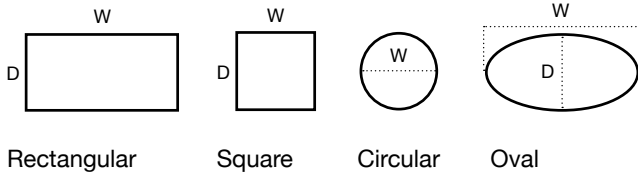

SPECIFICATION

- 25mm top made from grade E1 melamine faced high density particle board.

FRAME

- Steel frame with hydroformed tapered steel legs and cast aluminium feet.

METAL FINISHES



WOOD FINISHES



Wood finishes are heat, stain and scratch resistant when used for their intended purposes.



SPIRE MEETING TABLES

Rectangular, square, oval or circular tables tops are available to make the best use of your available space.

LINGWOOD BREAKOUT CHAIRS

Stylish and versatile chairs with a choice of different leg options and a selection of brightly coloured seats. **See page 150.**

ORDERING

Select the code for the product you require and simply add the metal and wood suffix to your code when ordering.

For example SPRE1880**CBI**

Metal: **W** White, **B** Matt Black, **S** Silver, **C** Chrome

Wood: **BE** Beech, **LO** Light Oak, **MA** Maple, **BI** Birch, **WH** White, **WA** Walnut

SPIRE

RECTANGULAR TABLES



800 Deep



1000 Deep



1200 Deep



1400 Deep

W x D x H (mm)	Code
800 Deep	
1800 x 800 x 740	SPRE1880
2000 x 800 x 740	SPRE2080
1000 Deep	
2000 x 1000 x 740	SPRE2010
1200 Deep	
2800 x 1200 x 740	SPRE2812
3200 x 1200 x 740	SPRE3212
3600 x 1200 x 740	SPRE3612
4200 x 1200 x 740	SPRE4212
4800 x 1200 x 740	SPRE4812
5400 x 1200 x 740	SPRE5412
1400 Deep	
2800 x 1400 x 740	SPRE2814
3200 x 1400 x 740	SPRE3214
3600 x 1400 x 740	SPRE3614
4200 x 1400 x 740	SPRE4214
4800 x 1400 x 740	SPRE4814
5400 x 1400 x 740	SPRE5414
5600 x 1400 x 740	SPRE5614
6400 x 1400 x 740	SPRE6414
7200 x 1400 x 740	SPRE7214

SQUARE TABLES



1200 Deep



1400 Deep

W x D x H (mm)	Code
1200 x 1200 x 740	SPSQ12
1400 x 1400 x 740	SPSQ14

CABLE MANAGEMENT

Don't let untidy cables tarnish the appearance of your workspace.
See page 184 to view the full range.



SLINKY CABLE MANAGER

Colour	Code
Black, Silver & White	ACCMSLINKY



ELLINGHAM
MEETING CHAIRS
Page 144

SPIRE

OVAL TABLES



1200 Deep



1600 Deep

W x D x H (mm)	Code
2000 x 1200 x 740	SPOV2012
2200 x 1200 x 740	SPOV2212
2400 x 1200 x 740	SPOV2412
2800 x 1200 x 740	SPOV2812
3600 x 1600 x 740	SPOV3616
4200 x 1600 x 740	SPOV4216

CIRCULAR TABLES



1200 Wide



1400 Wide



1600 Wide

W x H (mm)	Code
1200 x 740	SPRN12
1400 x 740	SPRN14
1600 x 740	SPRN16

SPIRE

SEATING CONFIGURATIONS

RECTANGULAR TABLES

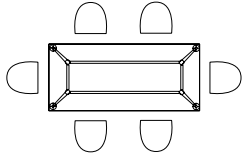

1800mm Wide
800mm Deep

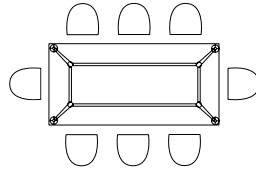

2000mm Wide
800 and 1000mm Deep

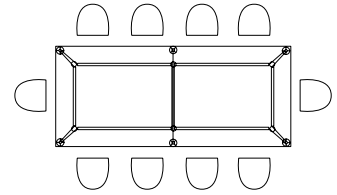

2800mm Wide
1200 and 1400mm Deep

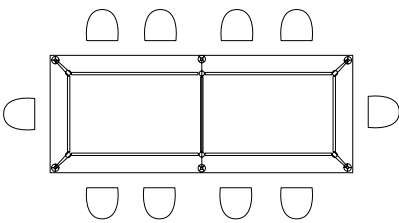

3200mm Wide
1200 and 1400mm Deep

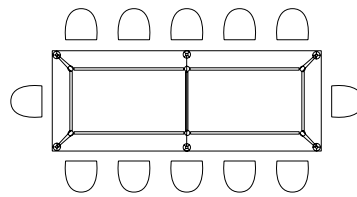

3600mm Wide
1200 and 1400mm Deep

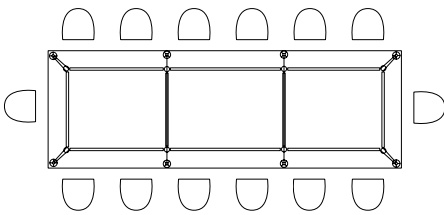

4200mm Wide
1200 and 1400mm Deep

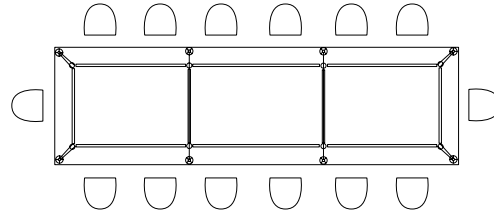

4800mm Wide
1200 and 1400mm Deep

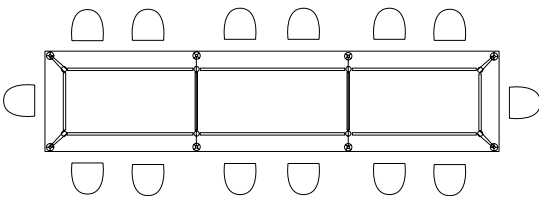

5400mm Wide
1200 and 1400mm Deep

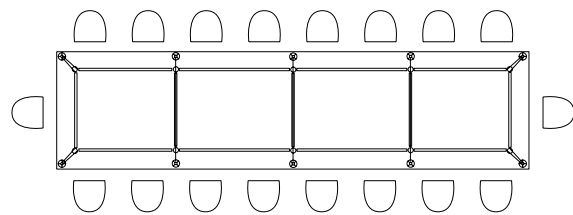

5600mm Wide
1400mm Deep

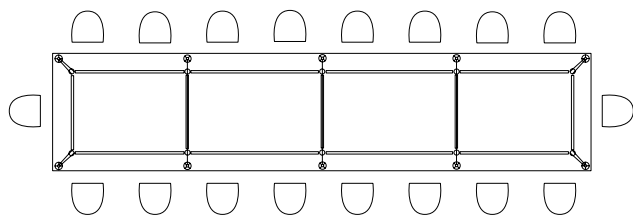

6400mm Wide
1400mm Deep

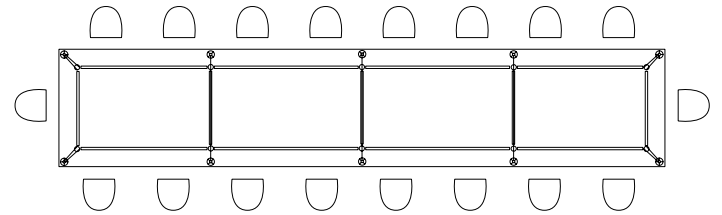

7200mm Wide
1400mm Deep

SPIRE

SEATING CONFIGURATIONS

CIRCULAR TABLES

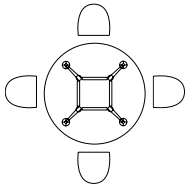

1200mm Diameter

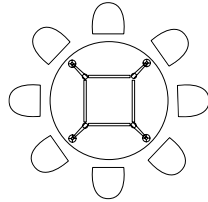

1400mm Diameter

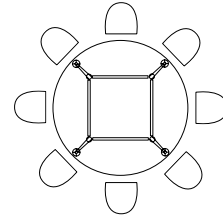

1600mm Diameter

OVAL TABLES

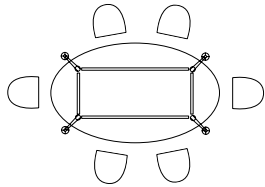

2000mm Wide
1200mm Deep

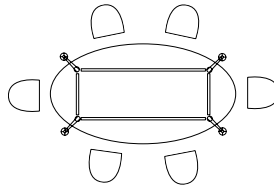

2200mm Wide
1200mm Deep

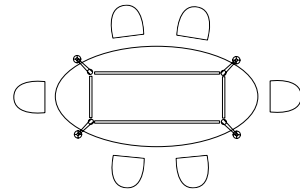

2400mm Wide
1200mm Deep

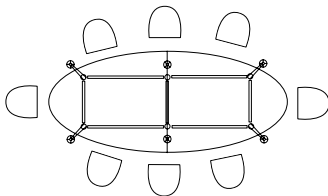

2800mm Wide
1200mm Deep

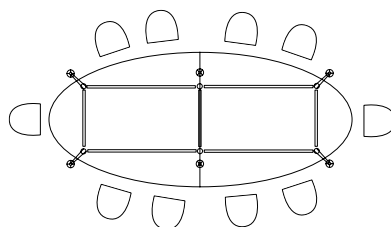

3600mm Wide
1600mm Deep

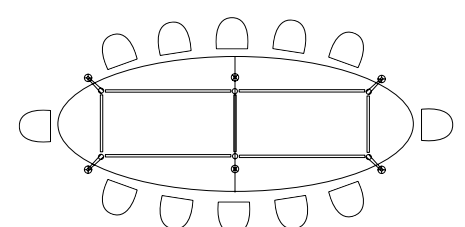

4200mm Wide
1600mm Deep

SQUARE TABLES

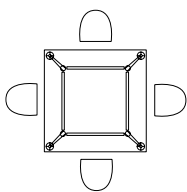

1200mm Square

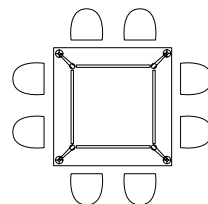

1400mm Square

Seating configurations are for illustrative purposes only and may vary depending upon the type and size of your seating. Please note position of intermediate legs. Chair shown is our Brandon meeting chairs on [page 145](#).

BARREL & OVAL



Available in a range of finishes, these large tables are well suited to boardrooms and meeting rooms, comfortably seating up to 8 people.



ELLINGHAM
MEETING CHAIRS

Page 144

FEATURES & DETAILS

TABLE SHAPES

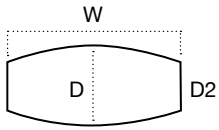

Barrel

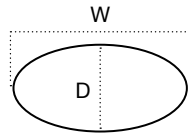

Oval

SPECIFICATION

- 25mm top made from grade E1 melamine faced high density particle board.
- Both tables include a double modesty panel.

FRAME OPTIONS

- Barrel boardroom table comes with stylish panel ends.
- Oval boardroom table is designed with a system cantilever in an I-frame style.

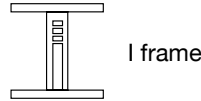

I frame

METAL FINISHES

BARREL TABLE



S Silver

OVAL TABLE



I Iron Grey

WOOD FINISHES



BE Beech **LO** Light Oak **MA** Maple **BI** Birch* **WH** White* **WA** Walnut*

* White, walnut and birch are available through our Bespoke Service.

Wood finishes are heat, stain and scratch resistant when used for their intended purposes.

BARREL TABLE

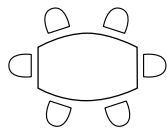

1800mm Wide

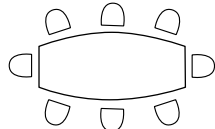

2400mm Wide

OVAL TABLE

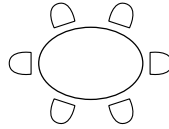

1800mm Wide

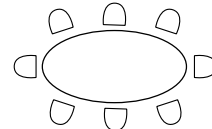

2400mm Wide

ORDERING

Select the code for the product you require and simply add the wood suffix to your code when ordering.

For example TBBB18PMMSBE

Wood: **BE** Beech, **LO** Light Oak, **MA** Maple, **BI** Birch*, **WH** White*, **WA** Walnut*



BARREL & OVAL



BARREL, TABLE



W x D x D2 x H (mm)	Wooden Modesty	Metal Modesty
1800 x 1200 x 800 x 725	TBBB18PCM	TBBB18PMMS
2400 x 1200 x 800 x 725	TBBB24PCM	TBBB24PMMS

OVAL, TABLE



W x D x H (mm)	Wooden Modesty
1800 x 1200 x 725	TBOB18SYI
2400 x 1200 x 725	TBOB24SYI



INFINITY
STORAGE
Page 124

BRANDON
MEETING CHAIRS
Page 145

DESKING RANGE TABLES

Beyond our extensive tables range, we also have a selection of tables available in our Desking section if you wish to create a consistent style throughout your workspace.



AURABENCH

AuraBench tables feature the sleek floating top and robust curved frame of our desking range.

See page 24 to view our AuraBench tables.

ASCEND

Available with rectangular or barrel table tops, Ascend tables are at the intersection of home and workplace design. With the quality of build you would expect for a working environment, and elegant style you would welcome in your home.

See page 58 to view our Ascend tables



DOMINOBEAM

As virtual meetings become more a part of working lives, the easy access cable management of DominoBeam makes it the perfect solution for getting your team together, wherever they are based.

See page 52 to view our DominoBeam tables.

SLED

With a modern 'O' leg frame and deep worktops, the Sled range is a contemporary addition to your workplace. Offering simplicity and robust build, it is well suited to meeting rooms and breakout areas.

Our NEW Sled tall table offers the opportunity to create multi-level working or dining environments when paired with our tall stools (see page 152)



LINGWOOD
HIGH STOOLS
Page 150

FEATURES & DETAILS

The industrial style design brings a contemporary urban look to your interior.

SPECIFICATION

- 43mm deep top.
- Self levelling feet on tables.

FRAME

- 50mm steel tube frame.



FEATURES & DETAILS

METAL FINISHES



S Silver



W White

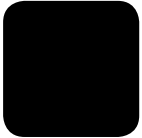

B Satin Black

WOOD FINISHES



BE Beech



LO Light Oak



MA Maple



BI Birch

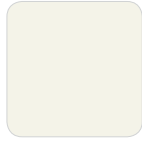

WH White



WA Walnut

Wood finishes are heat, stain and scratch resistant when used for their intended purposes.

ORDERING

Select the code for the product you require and simply add the metal and wood suffix to your code when ordering.

For example SLTB17**WBI**

Metal: **W** White, **S** Silver, **B** Black | **Wood:** **BE** Beech, **LO** Light Oak, **MA** Maple, **BI** Birch, **WH** White, **WA** Walnut

SLED TALL TABLE



W x D x H (mm)

1800 x 800 x 1050

Code

SLHT18

SLED TABLE



W x D x H (mm)

1800 x 800 x 740

Code

SLTB17

SLED BENCH



W x D x H (mm)

1600 x 350 x 460

Code

SLBE10

TILT TOP TABLES



Compact, mobile and easy to manoeuvre, our tilt top tables work well in multi-purpose spaces. For training, educational and breakout areas a tilt top table adapts to the facilities your need.



MOUNT
2 SEATER SOFAS
Page 164

ASHBY
BREAKOUT CHAIRS
Page 148



LINKING MECHANISM



Linking mechanism closed



Linking mechanism open

FEATURES & DETAILS

TABLE SHAPES

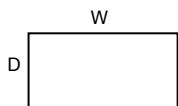

Rectangular

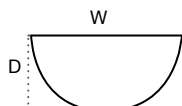

Semi-Circular

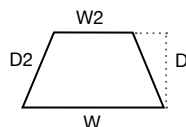

Trapezoidal 22.5°

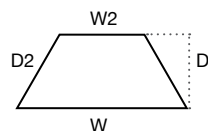

Trapezoidal 30°

SPECIFICATION

- 25mm top made from grade E1 melamine faced high density particle board.

FRAME

- Durable release and flip mechanism for ease of storage when not in use.
- All castors are lockable.
- A linking mechanism is available.

FEATURES & DETAILS

METAL FINISHES



S Silver

C Chrome

WOOD FINISHES



BE Beech

LO Light Oak

MA Maple

BI Birch

WH White

WA Walnut

Wood finishes are heat, stain and scratch resistant when used for their intended purposes.

ORDERING

Select the code for the product you require and simply add the metal and wood suffix to your code when ordering. For example TTRE16**SBI**

Metal: **S** Silver **W** White | **Wood:** **BE** Beech, **LO** Light Oak, **MA** Maple, **BI** Birch, **WH** White, **WA** Walnut



RECTANGULAR



W x D x H (mm)	Code
1200 x 800 x 720	TTRE12
1400 x 800 x 720	TTRE14
1600 x 800 x 720	TTRE16
1800 x 800 x 720	TTRE18

SEMI CIRCULAR



W x D x H (mm)	Code
1600 x 800 x 720	TTSC16

TRAPEZOIDAL



W x W2 x D x D2 x H (mm)	Code
Trapezoidal 22.5°	
1412 x 800 x 740 x 800 x 720 *	TTTP14Z2
Trapezoidal 30°	
1600 x 800 x 693 x 800 x 720 *	TTTP16Z3

* Both the 22.5° and the 30° Trapezoidal fit to the 800mm table end.

LINKING MECHANISM



Description	Code
Links 2 Tilt Top tables (2 per pack)	TTFTLMECH

FOLDING TABLES



Stackable and robust, our folding tables are perfect where space and storage are at a premium, or where spaces need to transform quickly and efficiently to different purposes. Perfect for conference, educational and community spaces.



INFINITY
STORAGE
Page 124

BRANDON
MEETING CHAIRS
Page 145

FEATURES & DETAILS

TABLE SHAPES

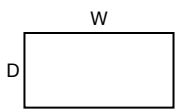

Rectangular

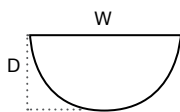

Semi-Circular

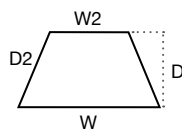

Trapezoidal 22.5°

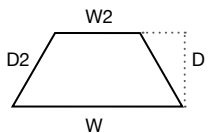

Trapezoidal 30°



SPECIFICATION

- 25mm top made from grade E1 melamine faced high density particle board.

FRAME

- Legs neatly fold under the table to enable easy storage.
- Tables are stackable.
- Tubular steel frame with strong metal supports and curved base.
- Height adjustable feet to reach 725mm.
- Legs supplied with angled anti-slip feet.
- A linking mechanism is available.

LINKING MECHANISM



Linking mechanism closed



Linking mechanism open

FEATURES & DETAILS

METAL FINISHES



C Chrome

WOOD FINISHES



BE Beech



LO Light Oak



MA Maple



BI Birch

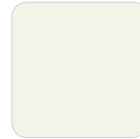

WH White



WA Walnut

Wood finishes are heat, stain and scratch resistant when used for their intended purposes.

ORDERING

Select the code for the product you require and simply add the wood suffix to your code when ordering.

For example FTRE12CBI

Wood: **BE** Beech, **LO** Light Oak, **MA** Maple, **BI** Birch, **WH** White, **WA** Walnut



RECTANGULAR



W x D x H (mm)	Code
1200 x 800 x 715	FTRE12C
1400 x 800 x 715	FTRE14C
1600 x 800 x 715	FTRE16C
1800 x 800 x 715	FTRE18C

SEMI CIRCULAR



W x D x H (mm)	Code
1600 x 800 x 715	FTSC16C

TRAPEZOIDAL



W x W2 x D x D2 x H (mm)	Code
Trapezoidal 22.5°	
1412 x 800 x 740 x 800 x 715 *	FTTP14Z2C
Trapezoidal 30°	
1600 x 800 x 693 x 800 x 715 *	FTTP16Z3C

* Both the 22.5° and the 30° Trapezoidal fit to the 800mm table end.

LINKING MECHANISM



Description	Code
Links 2 Folding Tables (2 per pack)	TTFTLMECH

DURABLE TABLES

Simple, robust, and easy to maintain, our durable tables are built to endure the wear and tear of high energy environments.



BRANDON
MEETING CHAIRS
Page 145

FEATURES & DETAILS

TABLE SHAPES

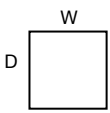

Square

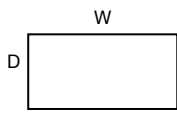

Rectangular

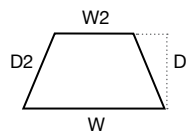

Trapezoidal 22.5°

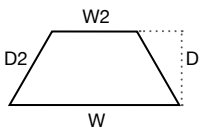

Trapezoidal 30°

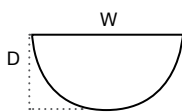

Semi-Circular

SPECIFICATION

- 25mm top made from grade E1 melamine faced high density particle board.

FRAME

- 38mm round legs using 2mm welded steel for strength and stability, Height adjustable feet.

FEATURES & DETAILS

METAL FINISHES



S Silver



G Grey

WOOD FINISHES



BE Beech



LO Light Oak



MA Maple



BI Birch

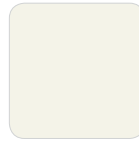

WH White



WA Walnut

Wood finishes are heat, stain and scratch resistant when used for their intended purposes.

ORDERING

Select the code for the product you require and simply add the metal and wood suffix to your code when ordering.

For example DTSQ66**SBE**

Metal: **S** Silver, **G** Grey | **Wood:** **BE** Beech, **LO** Light Oak, **MA** Maple, **BI** Birch, **WH** White, **WA** Walnut

SQUARE



W x D x H (mm)	Code
660 x 660 x 725	DTSQ66

RECTANGULAR



W x D x H (mm)	Code
1200 x 800 x 725	DTRE12
1400 x 800 x 725	DTRE14
1600 x 800 x 725	DTRE16

SEMI CIRCULAR



W x D x H (mm)	Code
1600 x 800 x 725	DTSC16

TRAPEZOIDAL



W x W2 x D x D2 x H (mm)	Code
Trapezoidal 22.5°	
1412 x 800 x 740 x 800 x 725	DTTP14Z2
Trapezoidal 30°	
1600 x 800 x 693 x 800 x 725	DTTP16Z3

ELECT

The clean lines of our Elect range offer a minimal style suited to any interior. Available in three heights, this adaptable range of round or square tables is perfect for both reception and breakout areas.



CAVIL
2 SEATER SOFAS
Page 168

ASHBY
BREAKOUT CHAIRS
Page 148

FEATURES & DETAILS

TABLE SHAPES

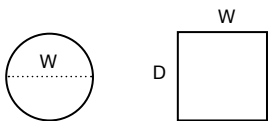

Circular

Square

SPECIFICATION

- 25mm top made from grade E1 melamine faced high density particle board.

FRAME

- High quality brushed steel square table base.



FEATURES & DETAILS

METAL FINISHES

BS Brushed Steel

WOOD FINISHES



BE Beech **LO** Light Oak **MA** Maple **BI** Birch **WH** White **WA** Walnut

Wood finishes are heat, stain and scratch resistant when used for their intended purposes.

ORDERING

Select the code for the product you require and simply add the metal and wood suffix to your code when ordering.

For example ELCORN80CB**BSBI**

Metal: **BS** Brushed Steel | **Wood:** **BE** Beech, **LO** Light Oak, **MA** Maple, **BI** Birch, **WH** White, **WA** Walnut

COFFEE TABLES



Round Table



Square Table

Table	W x H (mm)	Code
Round Table	600 x 450	ELCORN60CB
Round Table	800 x 450	ELCORN80CB
Square Table	600 x 450	ELCOSQ60CB
Square Table	800 x 450	ELCOSQ80CB

MEETING TABLES



Round Table



Square Table

Table	W x H (mm)	Code
Round Table	600 x 720	ELMTRN60CB
Round Table	800 x 720	ELMTRN80CB
Square Table	600 x 720	ELMTSQ60CB
Square Table	800 x 720	ELMTSQ80CB

POSEUR TABLES



Round Table



Square Table

Table	W x H (mm)	Code
Round Table	600 x 1100	ELPTRN60CB
Square Table	600 x 1100	ELPTSQ60CB

TABLES



Our wide range of bases and table tops offer variety to suit any interior. From furnishing meeting rooms and breakout areas, to simply creating more surfaces in working areas and public spaces, the addition of a few tables can reshape the workspace.



CUBE STOOLS

Page 175

LINGWOOD

BREAKOUT CHAIRS

Page 150

FEATURES & DETAILS

SPECIFICATION

- 25mm top made from grade E1 melamine faced high density particle board.

FRAME OPTIONS

- A variety of steel frame options are available including column base, round legs or square legs.



Round Legs

Column Base



Square Legs

FEATURES & DETAILS

METAL FINISHES

COLUMN BASE

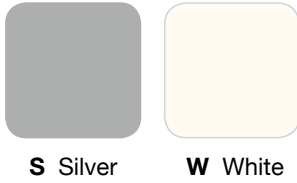

SQUARE LEGS

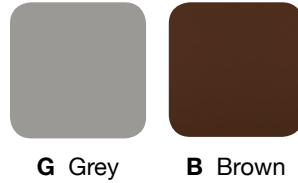

ROUND LEGS



WOOD FINISHES

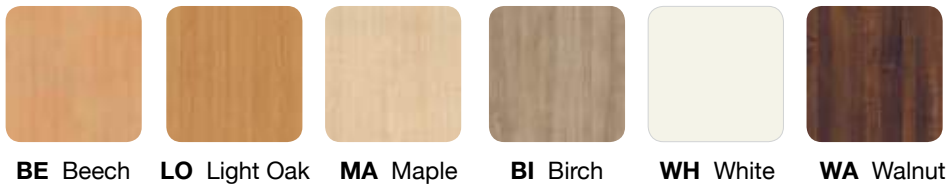

Wood finishes are heat, stain and scratch resistant when used for their intended purposes.

ORDERING

Select the code for the product you require and simply add the metal and wood suffix to your code when ordering. For example TBRN10CBSBI

SBE Silver metal work with Birch



ROUND TABLES



Column Base



Round Legs



Square Legs

W x H (mm)	Code
Column Base	
1000 x 725, Base Diameter 600mm, 25mm Top	TBRN10CB
1200 x 725, Base Diameter 600mm, 25mm Top	TBRN12CB
Round Base	
1000 x 725, 25mm Top	TBRN10RL
1200 x 725, 25mm Top	TBRN12RL
Square Legs	
1200 x 720, 18mm Top	TBMT12SQ

CHAIRS & STOOLS

Browse our range of contemporary chairs & stools from **page 144**.



Ashby Chairs

Lingwood Chairs

Wroxham Armchairs

TABLES



A selection of rectangular and D-end tables with a range of base options.



BRANDON
MEETING CHAIRS
Page 145

FEATURES & DETAILS

TABLE SHAPES

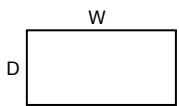

Rectangular

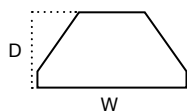

D End

SPECIFICATION

- 25mm or 18mm top made from grade E1 melamine faced high density particle board.

FRAME OPTIONS

- A variety of frame options are available including round legs, square legs and cantilever I frame.

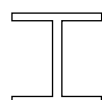

I frame

FEATURES & DETAILS

METAL FINISHES

**S** Silver**G** Grey**I** Iron Grey**B** Brown

WOOD FINISHES

**BE** Beech**LO** Light Oak**MA** Maple**BI** Birch**WH** White**WA** Walnut

Wood finishes are heat, stain and scratch resistant when used for their intended purposes.

Metal and wood finish options vary for different base options.

SQUARE LEGS

Grey metal work with Beech, Light Oak or Maple. Brown metal work with Light Oak.

I-FRAME

Silver or Grey metal work with Beech or Light Oak. Brown metal work with Light Oak.

ROUND LEGS

Silver, Grey or Iron Grey metal work with Beech. Light Oak or Maple (*Maple not applicable to D End*).

If you require different variations we can supply this through our Bespoke Service.

ORDERING

Select the code for the product you require and add the metal and wood suffix to your code when ordering.

For example **TBOT12SQGBE**

GBE Grey metal work with Beech

RECTANGULAR TABLE



Square Legs



I Frame



Round Legs

W x D x H (mm)	Code
Square Legs	
1200 x 615 x 720, 18mm Top	TBOT12SQ
1500 x 745 x 720, 18mm Top	TBOT15SQ
1800 x 745 x 720, 18mm Top	TBOT18SQ
I Frame	
1200 x 800 x 720, 18mm Top	TBOT12C
1600 x 800 x 720, 18mm Top	TBOT16C
Round Legs	
1200 x 800 x 725, 25mm Top	TBCT12RL
1600 x 800 x 725, 25mm Top	TBCT16RL
1800 x 800 x 725, 25mm Top	TBCT18RL

D-END TABLE



Round Legs

W x D x H (mm)	Code
Square Legs	
1200 x 600 x 725, 25mm Top	TBDE12RL
1600 x 800 x 725, 25mm Top	TBDE16RL

SIGNATURE



On Selected Items*

Featuring a distinctive panel base and matching feet, which come in either silver or white, the Signature storage range offers contemporary style in a comprehensive range of formats and finishes.



BRANDON
MEETING CHAIRS
Page 145

COMPREHENSIVE SOLUTION

- Unified range of 5 storage formats.
- 500mm deep units for maximum capacity.
- Distinctive base and feet in Silver or White.
- Optional espagnolette locks for added security.



FEATURES & DETAILS



* **Beech, Light Oak and White is available for Quick Ship Delivery.**

(excludes all 800mm wide cupboards, tambours and bookcases, 1000 x 1200mm and 1000 x 2000mm high cupboards, tambours and bookcases).

WOOD FINISHES

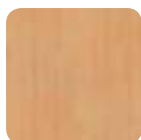

BE Beech



LO Light Oak



MA Maple

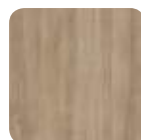

BI Birch

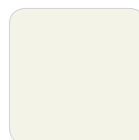

WH White



WA Walnut

BASE & FEET



S Silver

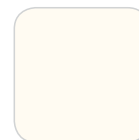

W White

Wood finishes are heat, stain and scratch resistant when used for their intended purposes.

UNITS:

Signature storage is available with either a White or Silver base and feet. The units have a choice of wood finishes.

SHELVES, SLIDING & LATERAL FILING FRAMES:

Shelving matches the colour finish of the base with the exception of bookcases where the colour of the shelving matches the unit. Sliding & Lateral Filing Frames are also available in Silver and White.

SPECIFICATION

- Manufactured from grade E1 melamine-faced high density particleboard.
- Silver bar handles as standard (other handle options are available).
- Polypropylene feet.
- The feet at the front of each unit have a height levelling mechanism built-in.
- Locking as standard.
- Shelves available to purchase separately (shelves provided with bookcases).
- We recommend units of 1800mm and above are fixed to a wall.



ORDERING

Select the code for the product you require and simply add the base and feet option and then the wood suffix to your code when ordering.

For example SRCU7410**SBI**

S Silver, **W** White | **Wood:** **BE** Beech, **LO** Light Oak, **MA** Maple, **BI** Birch, **WH** White, **WA** Walnut

ORDERING SHELVES, SLIDING & LATERAL FRAMES

Select the code for the product you require and simply add: **S** for Silver or **W** for White

DELIVERY

All storage is shipped flat packed, with the exception of desk high cupboards, desk high tambours, side filers and all filing cabinets, which are shipped assembled.

SIGNATURE

DESK HIGH UNITS

Desk high cupboards, tambours, bookcases, credenza, filing cabinets and side filer.
725mm and 740mm high units available.



On Selected Items

See page 115 for more information.

DESK HIGH, CUPBOARDS WITH STANDARD LOCK



725 High

740 High

W x D x H (mm)	Code
800 x 600 x 725	SRCU7280
1000 x 600 x 725	SRCU7210
800 x 600 x 740	SRCU7480
1000 x 600 x 740	SRCU7410

DESK HIGH CUPBOARDS WITH ESPAGNOLETTE LOCK

Upgrade your cupboard lock to an Espagnolette lock. Used for securing a door top and bottom by simply turning the key. Soft close hinge is also included, which will catch the door just before it closes to bring it to a soft, quiet stop.

W x D x H (mm)	Code
800 x 600 x 725	SRCU7280E
1000 x 600 x 725	SRCU7210E
800 x 600 x 740	SRCU7480E
1000 x 600 x 740	SRCU7410E

SHELVES, SLIDING & LATERAL FILING FRAMES

Shelves are available in Silver and White to complement the stylish panel base and feet.

Simply add the colour suffix to your code when ordering: **S** Silver **W** White

Optional Extras	800mm	1000mm
Single Shelf for Cupboards & Credenza	SRCU806SH1	SRCU106SH1
Sliding Filing Frame for Cupboards	SRCU80SFF	SRCU10SFF
Lateral Filing Frame for Cupboards	SRCU80LFF	SRCU10LFF

DESK HIGH, TAMBOUR CUPBOARDS



725 High

740 High

W x D x H (mm)	Code
800 x 600 x 725	SRTA7280
1000 x 600 x 725	SRTA7210
800 x 600 x 740	SRTA7480
1000 x 600 x 740	SRTA7410

Tambour doors come in a choice of Silver or White

SHELVES, SLIDING & LATERAL FILING FRAMES

Shelves are available in Silver and White to complement the stylish panel base and feet.

Simply add the colour suffix to your code when ordering: **S** Silver **W** White

Optional Extras	800mm	1000mm
Single Shelf for Tambours	SRTA806SH1	SRTA106SH1
Sliding Filing Frame for Tambours	SRTA80SFF	SRTA10SFF
Lateral Filing Frame for Tambours	SRTA80LFF	SRTA10LFF

SIGNATURE

DESK HIGH UNITS



On Selected Items

See page 115 for more information.

DESK HIGH, BOOKCASES



725 High

740 High

Bookcase	W x D x H (mm)	Code
Desk High 1 Shelf, Narrow	800 x 340 x 725	SRBC7280S1
Desk High 1 Shelf, Wide	1000 x 340 x 725	SRBC7210S1
Desk High 1 Shelf, Narrow	800 x 340 x 740	SRBC7480S1
Desk High 1 Shelf, Wide	1000 x 340 x 740	SRBC7410S1

All bookcases are supplied with the number of shelves illustrated.

DESK HIGH, CREDENZA



725 High

740 High

W x D x H (mm)	Code
800 x 600 x 725	SRCZ7280
1000 x 600 x 725	SRCZ7210
800 x 600 x 740	SRCZ7480
1000 x 600 x 740	SRCZ7410

The running track mechanism is hidden by the overhang of the top panel, with a concealed guide at the bottom.

SHELVES

Shelves are available in Silver and White to complement the stylish panel base and feet.

Simply add the colour suffix to your code when ordering: **S** Silver **W** White

Optional Extras	800mm	1000mm
Single Shelf for Cupboards & Credenza	SRCU806SH1	SRCU106SH1

DESK HIGH, FILING CABINET



725 High

740 High

Filing Cabinet	W x D x H (mm)	Code
2 Drawer	480 x 600 x 725	SRFC72D2
2 Drawer	480 x 600 x 740	SRFC74D2

DESK HIGH, SIDE FILER



725 High

740 High

W x D x H (mm)	Code
800 x 600 x 725	SRSF72D2
800 x 600 x 740	SRSF74D2

Both drawers feature Sliding Filing Frames as standard.

SIGNATURE



On Selected Items

See page 115 for more information.

CUPBOARDS WITH STANDARD LOCK



1000mm High

1200mm High

1600mm High



1800mm High

2000mm High

W x D x H (mm)	Code
800 x 500 x 1000	SRCU1080
1000 x 500 x 1000	SRCU1010
800 x 500 x 1200	SRCU1280
1000 x 500 x 1200	SRCU1210
800 x 500 x 1600	SRCU1680
1000 x 500 x 1600	SRCU1610
800 x 500 x 1800	SRCU1880
1000 x 500 x 1800	SRCU1810
800 x 500 x 2000	SRCU2080
1000 x 500 x 2000	SRCU2010

CUPBOARDS WITH ESPAGNOLETTE LOCK

Upgrade your cupboard lock to an Espagnolette lock. Used for securing a door top and bottom by simply turning the key. Soft close hinge is also included, which will catch the door just before it closes to bring it to a soft, quiet stop.

W x D x H (mm)	Code
800 x 500 x 1000	SRCU1080E
1000 x 500 x 1000	SRCU1010E
800 x 500 x 1200	SRCU1280E
1000 x 500 x 1200	SRCU1210E
800 x 500 x 1600	SRCU1680E
1000 x 500 x 1600	SRCU1610E
800 x 500 x 1800	SRCU1880E
1000 x 500 x 1800	SRCU1810E
800 x 500 x 2000	SRCU2080E
1000 x 500 x 2000	SRCU2010E

SHELVES, SLIDING & LATERAL FILING FRAMES

Shelves, Sliding & Lateral Frames are available in Silver and White to complement the stylish panel base and feet.

Simply add the colour suffix to your code when ordering: **S** Silver **W** White

Optional Extras	800mm	1000mm
Single Shelf for Cupboards & Credenza	SRCU805SH1	SRCU105SH1
Sliding Filing Frame for Cupboards	SRCU80SFF	SRCU10SFF
Lateral Filing Frame for Cupboards	SRCU80LFF	SRCU10LFF



On Selected Items
See page 115 for more information.

TAMBOUR CUPBOARDS



1000mm High

1200mm High

1600mm High



1800mm High

2000mm High

W x D x H (mm)	Code
800 x 500 x 1000	SRTA1080
1000 x 500 x 1000	SRTA1010
800 x 500 x 1200	SRTA1280
1000 x 500 x 1200	SRTA1210
800 x 500 x 1600	SRTA1680
1000 x 500 x 1600	SRTA1610
800 x 500 x 1800	SRTA1880
1000 x 500 x 1800	SRTA1810
800 x 500 x 2000	SRTA2080
1000 x 500 x 2000	SRTA2010

Tambour doors come in a choice of Silver or White to tie in with the modern panel base and feet.

SHELVES, SLIDING & LATERAL FILING FRAMES

Shelves, Sliding & Lateral Frames are available in Silver and White to complement the stylish panel base and feet.

Simply add the colour suffix to your code when ordering: **S** Silver **W** White

Optional Extras	800mm	1000mm
Single Shelf for Tambours	SRTA805SH1	SRTA105SH1
Sliding Filing Frame for Tambours	SRTA80SFF	SRTA10SFF
Lateral Filing Frame for Tambours	SRTA80LFF	SRTA10LFF





PERSPEX
SCREENS
Page 180

AURABENCH
DESKING
Page 16

SIGNATURE



On Selected Items
See page 115 for more information.

BOOKCASES



1 Shelf



2 Shelves



3 Shelves



4 Shelves, 1800 High



4 Shelves, 2000 High

Bookcase	W x D x H (mm)	Code
1 Shelf, Narrow	800 x 340 x 1000	SRBC1080S1
1 Shelf, Wide	1000 x 340 x 1000	SRBC1010S1
2 Shelves, Narrow	800 x 340 x 1200	SRBC1280S2
2 Shelves, Wide	1000 x 340 x 1200	SRBC1210S2
3 Shelves, Narrow	800 x 340 x 1600	SRBC1680S3
3 Shelves, Wide	1000 x 340 x 1600	SRBC1610S3
4 Shelves, Narrow	800 x 340 x 1800	SRBC1880S4
4 Shelves, Wide	1000 x 340 x 1800	SRBC1810S4
4 Shelves, Narrow	800 x 340 x 2000	SRBC2080S4
4 Shelves, Wide	1000 x 340 x 2000	SRBC2010S4

All bookcases are supplied with the number of shelves illustrated.

SIGNATURE



On Selected Items

See page 115 for more information.

FILING CABINET



3 Drawer

4 Drawer

Filing Cabinet	W x D x H (mm)	Code
3 Drawer	480 x 600 x 1070	SRFC10D3
4 Drawer	480 x 600 x 1400	SRFC14D4

See **page 117** for desk high 2 drawer filing cabinets.

CREDENZA



1000mm High

1200mm High

W x D x H (mm)	Code
800 x 500 x 1000	SRCZ1080
1000 x 500 x 1000	SRCZ1010
800 x 500 x 1200	SRCZ1280
1000 x 500 x 1200	SRCZ1210

The running track mechanism is hidden by the overhang of the top panel, with a concealed guide at the bottom.

SHELVES

Shelves are available in Silver and White to complement the stylish panel base and feet.

Simply add the colour suffix to your code when ordering: **S** Silver **W** White

Optional Extras	800mm	1000mm
Single Shelf for Cupboards & Credenza	SRCU805SH1	SRCU105SH1



MOULTON

TASK CHAIRS

Page 138

STORAGE SHELF SPACING

SIGNATURE

Illustrations shows 800mm wide, holding 10 box files per shelf. 1000mm wide units hold 13 box files per shelf. Please note, for Tambour cupboards 800mm wide unit holds 8 per shelf and 1000mm wide hold 10 box files per shelf.

A4 BOX FILES



(340mm high)

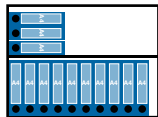

725 / 740mm High

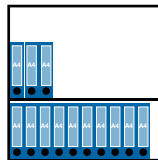

1000mm High

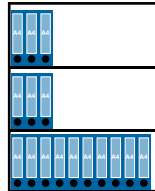

1200mm High

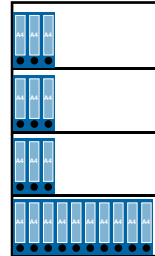

1600mm High



1800mm High

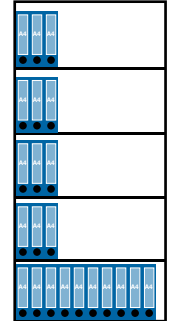

2000mm High

FOOLSCAP BOX FILES



(370mm high)

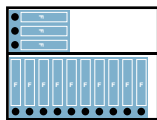

725 / 740mm High

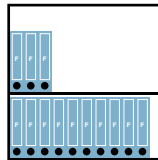

1000mm High

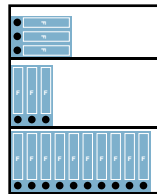

1200mm High

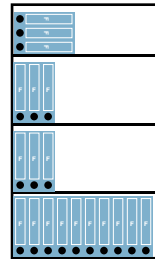

1600mm High

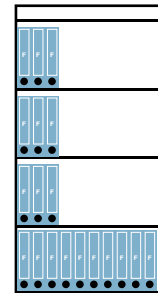

1800mm High

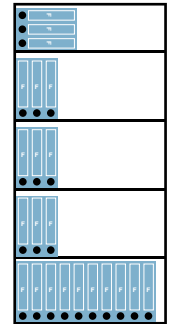

2000mm High

LATERAL FILING FRAMES

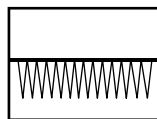
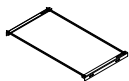

725 / 740mm High

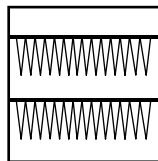

1000mm High

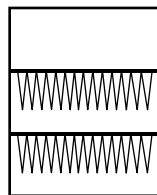

1200mm High

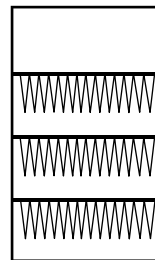

1600mm High

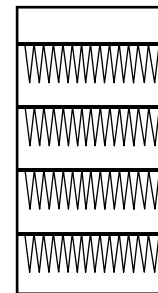

1800mm High

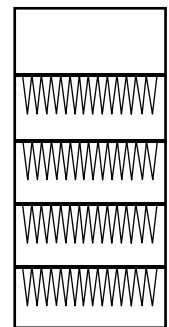

2000mm High

SLIDING FILING FRAMES

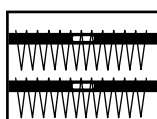
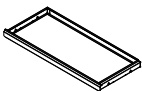

725 / 740mm High

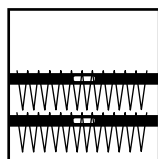

1000mm High

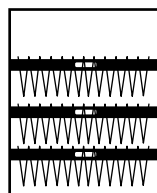

1200mm High

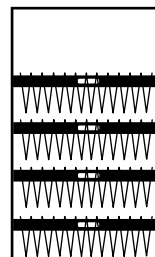

1600mm High

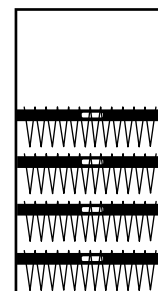

1800mm High

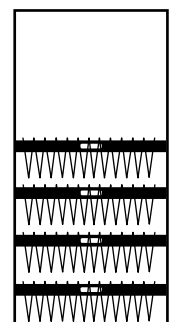

2000mm High

Not all products include internal fitting as standard. Please refer to individual product codes.
Box files assumed to be 70mm wide. Box file sizes are estimate and different brands may vary.



INFINITY

Infinity is a modular storage and display system which can be scaled and altered to meet your needs. With glass or solid doors, or open shelving, and a range of unit heights, the narrower depth of Infinity enables you to achieve maximum capacity even in areas where space is at a premium.

CREATE YOUR PERFECT DISPLAY

- 5 unit heights
- Frosted or clear glass, or solid doors
- Additional shelves available.

INFINITY

From left to right: 1 shelf unit combination 1, 2 shelf unit combination 1, 3 shelf unit combination 5, 4 shelf unit combination 6 all in white.



FEATURES & DETAILS

UNIT HEIGHTS

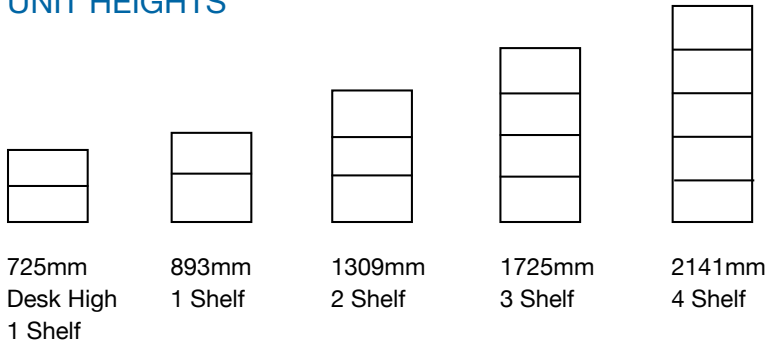

WOOD FINISHES



BE Beech **LO** Light Oak **MA** Maple **BI** Birch **WH** White **WA** Walnut

Wood finishes are heat, stain and scratch resistant when used for their intended purposes.

UNIT SPECIFICATION (1 – 4 SHELVES)

- 25mm unit tops made from grade E1 melamine faced high density particle board.
- 18mm side and back panels.
- Units are suitable for box files.
- 25mm shelves.
- All units are supplied with the number of shelves illustrated.
- Fixed or removable shelves.
- Locking shelf fixings provide extra rigidity and prevent outward bowing of the base units.

NB: A fixed shelf is required for positioning below upper door and above lower doors where full length doors are not used.

You must have a fixed shelf for all cupboards where doors are not full length, otherwise the latch will not have anything to attach to.

DESK HIGH UNITS

- 18mm side and back panels.
- 18mm shelves to accommodate A4 folders.
- Adjustable feet are supplied.
- Units are not suitable for box files.

WOOD EFFECT DOORS

- 18mm doors made from grade E1 melamine faced high density particle board.
- Silver effect bow handles.
- Doors are lockable (excluding glass doors).
- Soft closing hinges are available.

GLASS DOORS

- Doors are made from toughened glass to comply with the safety standard BS6206A.
- Silver effect bow handles.
- Soft closing hinges are available.

ORDERING

Select the code for the product you require and simply add the wood suffix to your code when ordering.

For example IFBU89S1**BI**

Wood: **BE** Beech, **LO** Light Oak, **MA** Maple, **BI** Birch, **WH** White, **WA** Walnut

INFINITY

INDIVIDUAL ITEMS

Infinity has been designed as a versatile, modular storage range to enable you to find your perfect solution.

To create your own design combination, simply choose your base unit, followed by a selection of door options. Additional shelves and soft close hinges are also available.

CREATE YOUR OWN INFINITY UNIT



INDIVIDUAL ITEMS

BOOKCASES (BASE UNIT)



Desk High 1 Shelf

1 Shelf

2 Shelves

3 Shelves

4 Shelves

Bookcase	W x D x H (mm)	Code
Desk High, 1 Shelf	800 x 350 x 725	IFBU72DH
1 Shelf	800 x 330 x 893	IFBU89S1
2 Shelves	800 x 330 x 1309	IFBU13S2
3 Shelves	800 x 330 x 1725	IFBU17S3
4 Shelves	800 x 330 x 2141	IFBU21S4

All units are supplied with the number of shelves illustrated.

4 shelf units must be secured to the wall.

WOOD EFFECT DOORS



Lower Doors – Desk High, 1, 2, 3 and 4 Shelves

Upper Doors – 1 and 2 Shelves

Wood Effect Doors	W x H (mm) Per door	Code
1 Shelf, Desk High Door	395 x 663	IFLD66DH
1 Shelf, Upper Door	395 x 828	IFUD82S1
1 Shelf, Lower Door	395 x 828	IFLD82S1
2 Shelves, Upper Door	395 x 1244	IFUD12S2
2 Shelves, Lower Door	395 x 1244	IFLD12S2
3 Shelves, Lower Door	395 x 1660	IFLD16S3
4 Shelves, Lower Door	395 x 2076	IFLD20S4



Clear Glass – 1 and 2 Shelves



Opaque Glass – 1 and 2 Shelves

GLASS DOORS

Glass Doors	W x H (mm) Per door	Code
1 Shelf, Clear Glass	395 x 828	IFGD82S1CL
1 Shelf, Opaque Glass	395 x 828	IFGD82S1OP
2 Shelves, Clear Glass	395 x 1244	IFGD12S2CL
2 Shelves, Opaque Glass	395 x 1244	IFGD12S2OP

SHELVES

Shelves	W x H x D (mm)	Description	Code
1 Shelf	762 x 306 x 18	For desk high unit	IFDH18SH1
1 Shelf	762 x 306 x 25	For all units (except Desk High)	IFAC25SH1
Fixed Shelf	762 x 306 x 25	Required for positioning below upper door and above lower doors where full length doors are not used.	IFAC25FX

You must have a fixed shelf for all cupboards where doors are not full length, otherwise the latch will not have anything to attach to.

SOFT CLOSE HINGES

Description	Code
Two Pair Pack	IFHINGE2
Three Pair Pack	IFHINGE3

HANDLES

We also offer a range of handles to customise the range further

Handles	Description	Colour	Code
Bow Handles	Pack of 10	Silver	ACBOWS
Mosaic Handles	Pack of 10	Silver	ACMOSAICS
Matrix Handles	Pack of 10	Silver	ACMATRIXS
Oval Handles	Pack of 10	Silver	ACOVALS

INFINITY

INFINITY COMBINATION UNITS

Infinity is available in a variety of ready-made combinations. A selection of these are displayed below.

EASILY ADAPTABLE

Designed to provide a multitude of configurations by using various size base units, adjustable shelves and door options, Infinity will scale to your requirements.

DESK HIGH UNITS



Bookcase



Combination 1

Combination	W x D x H (mm)	Description	Code
Bookcase (Base Unit)	800 x 350 x 725	1 shelf	IFBU72DH
Combination 1	800 x 350 x 725	1 shelf desk high with full wooden doors	IFC172DH

1 SHELF UNITS



Bookcase



Combination 1

Combination	W x D x H (mm)	Description	Code
Bookcase (Base Unit)	800 x 330 x 893	1 shelf	IFBU89S1
Combination 1	800 x 330 x 893	1 shelf with full wooden doors	IFC189S1

2 SHELF UNITS



Bookcase



Combination 1



Combination 2

Combination	W x D x H (mm)	Description	Code
Bookcase (Base Unit)	800 x 330 x 1309	2 shelves	IFBU13S2
Combination 1	800 x 330 x 1309	2 shelves with 1 shelf lower wooden doors	IFC113S2
Combination 2	800 x 330 x 1309	2 shelves full wooden doors	IFC213S2

3 SHELF UNITS



Bookcase



Combination 1



Combination 2



Combination 3



Combination 4



Combination 5



Combination 6



Combination 7

Combination	W x D x H (mm)	Description	Code
Bookcase (Base Unit)	800 x 330 x 1725	3 shelves	IFBU17S3
Combination 1	800 x 330 x 1725	3 shelves with 1 shelf lower wooden doors	IFC117S3
Combination 2	800 x 330 x 1725	3 shelves with 2 shelf lower wooden doors	IFC217S3
Combination 3	800 x 330 x 1725	3 shelves with full wooden doors	IFC317S3
Combination 4	800 x 330 x 1725	3 shelves with 2 shelf upper wooden doors	IFC1017S3
Combination 5	800 x 330 x 1725	3 shelves with 1 shelf lower wooden doors and 2 shelf clear glass doors	IFC1117S3
Combination 6	800 x 330 x 1725	3 shelves with 1 shelf lower wooden doors and 2 shelf upper opaque glass doors	IFC1217S3
Combination 7	800 x 330 x 1725	3 shelves 1 shelf lower wooden doors and 2 shelf upper wooden doors	IFC1617S3

INFINITY

INFINITY COMBINATION UNITS

4 SHELF UNITS

4 shelf units must be secured to the wall.



Bookcase



Combination 1



Combination 2



Combination 3



Combination 4



Combination 5



Combination 6



Combination 7



Combination 8



Combination 9



Combination 10



Combination 11



Combination 12



Combination 13



Combination 14



Combination 15



Combination 16



Combination 17



Combination 18



Combination 19



Combination 20



Image features, from left to right: 4 shelf units including combination 11, a bookcase, combination 2 and 16 all in maple.

Combination	W x D x H (mm)	Description	Code
Bookcase (Base Unit)	800 x 330 x 2141	4 shelves	IFBU21S4
Combination 1	800 x 330 x 2141	4 shelves with 1 shelf lower wooden doors	IFC121S4
Combination 2	800 x 330 x 2141	4 shelves with 2 shelves lower wooden doors	IFC221S4
Combination 3	800 x 330 x 2141	4 shelves with 3 shelves lower wooden doors	IFC321S4
Combination 4	800 x 330 x 2141	4 shelves with full wooden doors	IFC421S4
Combination 5	800 x 330 x 2141	4 shelves with 2 shelf upper clear glass doors	IFC521S4
Combination 6	800 x 330 x 2141	4 shelves with 3 shelf upper clear glass doors	IFC621S4
Combination 7	800 x 330 x 2141	4 shelves with 2 shelf upper opaque glass doors	IFC921S4
Combination 8	800 x 330 x 2141	4 shelves with 3 shelf upper opaque glass doors	IFC1021S4
Combination 9	800 x 330 x 2141	4 shelves with 1 shelf lower and 2 shelf upper wooden doors	IFC1321S4
Combination 10	800 x 330 x 2141	4 shelves with 1 shelf lower wooden doors and 2 shelf upper clear glass doors	IFC1421S4
Combination 11	800 x 330 x 2141	4 shelves with 1 shelf lower wooden doors and 3 shelf clear glass doors	IFC1521S4
Combination 12	800 x 330 x 2141	4 shelves with 1 shelf lower wooden doors and 2 shelf upper opaque doors	IFC1621S4
Combination 13	800 x 330 x 2141	4 shelves with 1 shelf lower wooden doors and 3 shelf upper opaque doors	IFC1721S4
Combination 14	800 x 330 x 2141	4 shelves with 1 shelf lower and 2 shelf upper wooden doors	IFC1821S4
Combination 15	800 x 330 x 2141	4 shelves with 1 shelf lower wooden doors and 3 shelf upper wooden doors	IFC1921S4
Combination 16	800 x 330 x 2141	4 shelves with 2 shelf lower wooden doors and 2 shelf upper clear glass doors	IFC2021S4
Combination 17	800 x 330 x 2141	4 shelves with 2 shelf lower wooden doors and 2 shelf upper opaque glass doors	IFC2121S4
Combination 18	800 x 330 x 2141	4 shelves with 2 shelf lower wooden doors and 2 shelf upper wooden doors	IFC2221S4
Combination 19	800 x 330 x 2141	4 shelves with 1 shelf upper wooden doors	IFC3221S4
Combination 20	800 x 330 x 2141	4 shelves with 3 shelf upper wooden doors	IFC3321S4

TASK CHAIRS

We have a range of task chair options to suit your individual office requirements. All chairs are available in a variety of colours to complement your interior design.

The correct **office chair** is one of the most important pieces of equipment in many workplaces.

Ergonomic chair features provide the very best in **posture support** and are widely recommended by health care professionals.



ORDERING

Select the code for the product you require and simply add the optional extra suffix to your code, then add your fabric choice.

For example CHRAMBG2/A2D/AB/HR1
Seat: Camira Xtreme YS160 Tonga
Headrest: Camira Xtreme YS084 Tarot



5 Year Guarantee on all chairs, unless specified.
2 Year Guarantee on moving parts, unless specified.
Fabric Guarantee as per manufacturer instructions.

ERGONOMIC SEATING



50 million
working days are lost in the UK each year.

£5 billion per year
The estimated cost of sickness absence in the UK economy.

75% of the working population in the UK
spend more than 6 hours per day in a chair.

The second largest cause of office absence in Europe
is lower back pain.

The largest cause of disability for workers under the age of 45
is lower back pain.

40% of the UK population
are affected by back pain.

Estimates show that for each person off sick with back pain,
13 others will suffer in silence

“All the above information points towards the necessity for seating that offers adequate, variable and flexible support which can be adjusted sufficiently to suit the majority of the workforce.”

Gilly Fairhurst
Bsc (hons) Physiotherapy, HCPC registered,
Member of ACPOHE, Level 1 DSE training.



DRAYTON

DRAYTON CHAIR (WITH HEADREST & SEAT SLIDE)



DRAYTON CHAIR (WITH HEADREST)

Features

- Height adjustable headrest
- Seat slide
- High black mesh back with adjustable lumbar
- Three-position lock synchro mechanism
- Height, depth and width adjustable arms
- CMHR moulded foam seat with black fabric
- Gas lift height adjustment

Code

CHDRHBK

Our new Drayton mesh back task chair benefits from a range of features including adjustable arms and lumbar support.

DIMENSIONS

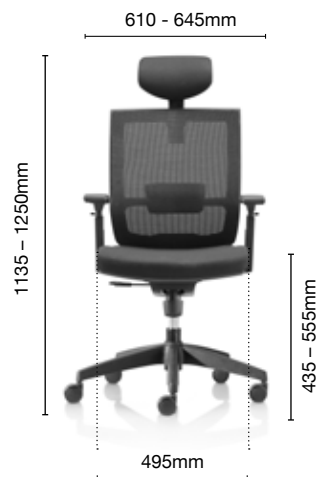

Drayton Chair, (With Headrest and Seat Slide)



Adjustable Headrest



Seat Slide

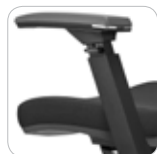

3 Way Adjustable Arms



Adjustable Lumbar



Three-Position Lock Synchro Mechanism

The Drayton task chair is available in black with a CMHR moulded foam seat.
1 Year Guarantee.

DRAYTON CHAIR (WITHOUT HEADREST & SEAT SLIDE)



DRAYTON CHAIR (WITHOUT HEADREST)

Features

- High black mesh back with adjustable lumbar
- Three-position lock synchro mechanism
- Height and depth adjustable arms
- CMHR moulded foam seat with black fabric
- Gas lift height adjustment

Code

CHDRNBK

The Drayton task chair provides flexibility and comfort designed to suit various types of seating requirements.

Drayton Chair, (Without Headrest and Seat Slide)



2 Way
Adjustable Arms



Adjustable
Lumbar



Three-Position
Lock Synchro
Mechanism

The Drayton task chair is available in black with a CMHR moulded foam seat.
1 Year Guarantee.

DIMENSIONS

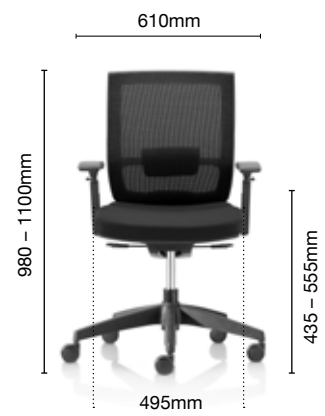

RANWORTH

An executive high back task chair which promotes good posture and comfort. Available in upholstered and mesh back options.



For colour fabric groups refer to page 186 and for fabric swatches see page 192.





RANWORTH CHAIR, UPHOLSTERED BACK

Standard Features

- Executive synchro mechanism
- Flex front seat
- High moulded outer back
- Push button back height adjustment
- Body weight tension control
- Twin seat slide
- Gas lift height adjustment
- Max weight 114kg

Fabric Group	Code
Fabric Group 1	CHRAUBG1
Fabric Group 2	CHRAUBG2
Fabric Group 3	CHRAUBG3
Fabric Group 4	CHRAUBG4

Prices include standard features only, see optional extras.

OPTIONAL EXTRAS

Optional Extras	Code
Brake Unloaded Castors	BUC
Brake Loaded Castors	BLC
Soft Wheeled Castors	SWC
Height Adjustable Arms	ADJ5
Height & Depth Adjustable Arms (Soft Touch Pad)	A2D
Multifunctional Arms (Height, Depth, Width)	AMF
Polished Base	AB
Adjustable Headrest	HR1
Air Flo Soft Seat Cell	ASC
Performance / Memory Foam	PF
Inflatable Lumbar (Upholstered back only)	IL



RANWORTH CHAIR, MESH BACK

Standard Features

- Executive synchro mechanism
- Flex front seat
- High mesh back
- Lever back height adjustment
- Body weight tension control
- Twin seat slide
- Gas lift height adjustment
- Adjustable lumbar panel
- Max weight 114kg

Fabric Group	Code
Fabric Group 1	CHRAMBG1
Fabric Group 2	CHRAMBG2
Fabric Group 3	CHRAMBG3
Fabric Group 4	CHRAMBG4



For colour fabric groups refer to page 186.

DIMENSIONS

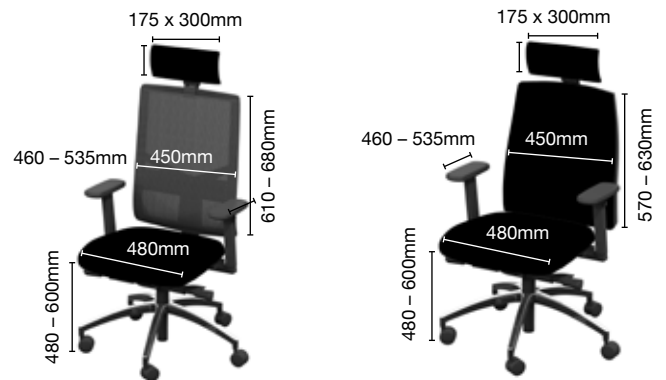

Ranworth Chair,
Upholstered Back

Ranworth Chair,
Mesh Back

MOULTON

Comfortable and stylish seating to suit any office.
Available in upholstered and mesh back options.



For colour fabric groups refer to page 186
and for fabric swatches see page 192.





MOULTON CHAIR, UPHOLSTERED BACK

Standard Features

- High moulded outer back rest
- Body weight responsive mechanism
- Ratchet back height adjustment
- Flex front seat
- Gas lift height adjustment
- Max weight 114kg

Fabric Group	Code
Fabric Group 1	CHMOUBG1
Fabric Group 2	CHMOUBG2
Fabric Group 3	CHMOUBG3
Fabric Group 4	CHMOUBG4

Prices include standard features only, see optional extras.

OPTIONAL EXTRAS

Optional Extras	Code
Brake Unloaded Castors	BUC
Brake Loaded Castors	BLC
Soft Wheeled Castors	SWC
Height Adjustable Arms	ADJ1
Height & Depth Adjustable Arms (Soft Touch Pad)	ADJ3
Seat Slide	SL
Polished Base	AB
Air Flo Soft Seat Cell	ASC
Performance / Memory Foam	PF
Inflatable Lumbar (Upholstered back only)	IL



MOULTON CHAIR, MESH BACK

Standard Features

- Mesh back rest
- Body weight responsive mechanism
- Fixed back height
- Flex front seat
- Gas lift height adjustment
- Adjustable padded lumbar panel
- Max weight 114kg

Fabric Group	Code
Fabric Group 1	CHMOMBG1
Fabric Group 2	CHMOMBG2
Fabric Group 3	CHMOMBG3
Fabric Group 4	CHMOMBG4



For colour fabric groups refer to page 186.

DIMENSIONS

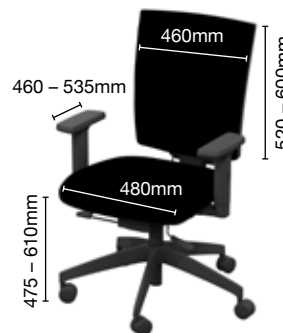

Moulton Chair,
Upholstered Back

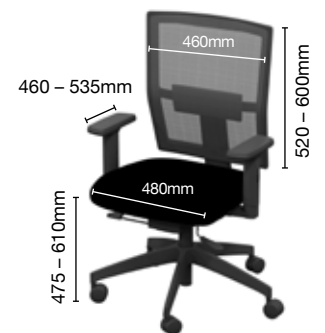

Moulton Chair,
Mesh Back

SALHOUSE

Fully functional seating that doesn't compromise on design.
Available in upholstered and mesh back options.



For colour fabric groups **refer to page 186**
and for fabric swatches **see page 192**.





SALHOUSE CHAIR, UPHOLSTERED BACK

Standard Features

- High moulded outer back rest
- Seat and back angle mechanism
- Ratchet back height adjustment
- Large waterfall seat
- Gas lift height adjustment
- Max weight 114kg

Fabric Group	Code
Fabric Group 1	CHSAUBG1
Fabric Group 2	CHSAUBG2
Fabric Group 3	CHSAUBG3
Fabric Group 4	CHSAUBG4

Prices include standard features only, see optional extras.

OPTIONAL EXTRAS

Optional Extras	Code
Brake Unloaded Castors	BUC
Brake Loaded Castors	BLC
Soft Wheeled Castors	SWC
Height Adjustable Arms	ADJ1
Height & Depth Adjustable Arms (Soft Touch Pad)	ADJ3
Seat Slide	SL
Polished Base	AB
Air Flo Soft Seat Cell	ASC
Performance / Memory Foam	PF
Inflatable Lumbar Support (Upholstered back only)	IL



SALHOUSE CHAIR, MESH BACK

Standard Features

- Mesh back rest
- Seat and back angle mechanism
- Ratchet back height adjustment
- Large waterfall seat
- Adjustable padded lumbar panel
- Gas lift height adjustment
- Max weight 114kg

Fabric Group	Code
Fabric Group 1	CHSAMBG1
Fabric Group 2	CHSAMBG2
Fabric Group 3	CHSAMBG3
Fabric Group 4	CHSAMBG4



For colour fabric groups refer to page 186.

DIMENSIONS

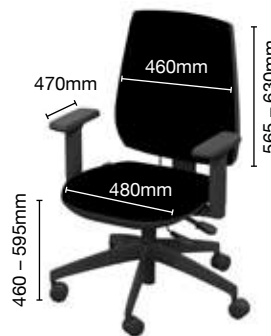

Salhouse Chair,
Upholstered Back

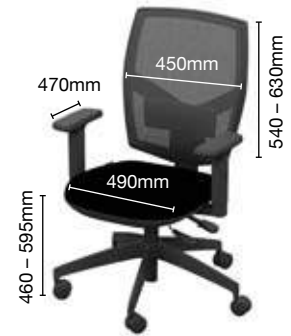

Salhouse Chair,
Mesh Back

ILOA



On Selected Items

The ILOA swivel saddle stool, designed by Jonas Hakaniemi, encourages good posture. A designer solution to the health concerns of sedentary workspaces, ILOA will change the way you work.



AURABENCH
DESKING
Page 16

SPECIFICATION

- Double twin-wheel castors.
- Gas lift height adjustment.
- Sitting height (from middle of the seat)
ILOA 49 – 74 cm, ILOA one & ILOA+ 53 – 78 cm.
- A maximum weight load of 120kg.

5 Year Guarantee.



ILOA

No upholstery. Available in Light Birch or Black Ash.



ILOA+

Features comfortable seat pads, upholstered with a selection of high quality fabric or Eco Black leather.



ILOA ONE

One-piece upholstery with a selection of high quality fabric or Eco Black leather.

ILOA

The diverse ILOA stool in light birch is available with Quick Ship Delivery



ILOA

ILOA	Code
Birch	CHILB

The comfortable ILOA + with black eco leather on black ash is available with Quick Ship Delivery



ILOA +

ILOA +	Code
Black Eco Leather on Black Ash	CHILPBLA

ILOA



ILOA	Code
Black Ash	CHILA

ILOA ONE



ILOA One	Code
Finish Options Below	CHILO

ILOA +



ILOA +	Code
Finish Options Below	CHILP

FINISHES, ILOA ONE & ILOA +



Black Wool / Birch
BWB



Grey Wool / Birch
GWB



Orange Wool / Birch
OWB



Black Eco Leather / Birch
BLB



Black Eco Leather / Black Ash
BLA



Black Wool / Black Ash
BWA



Grey Wool / Black Ash
GWA



Orange Wool / Black Ash
OWA

ORDERING

Select the code for the product you require and simply add the colour suffix when ordering.

For example **CHILOBWB**
Black Wool / Birch

ELLINGHAM

Comfortable and stylish meeting and conference chair available with an upholstered or mesh back.



For colour fabric groups **refer to page 186** and for fabric swatches **see page 192**.



Chrome Frame
also available see
optional extras.



ELLINGHAM MEETING CHAIR, UPHOLSTERED BACK

Standard Features

- Visitor chair (Black frame)
- Flex front seat
- High moulded outer back
- Push button back height adjustment
- Optional fixed T arms
- Max weight 109kg

Upholstered Back

Code

Fabric Group 1	CHELUBG1
Fabric Group 2	CHELUBG2
Fabric Group 3	CHELUBG3
Fabric Group 4	CHELUBG4

ELLINGHAM MEETING CHAIR, MESH BACK

Standard Features

- Visitor chair (Black frame)
- Flex front seat
- Mesh back
- Lever back height adjustment
- Optional fixed T arms
- Max weight 109kg

Mesh Back

Code

Fabric Group 1	CHELMBG1
Fabric Group 2	CHELMBG2
Fabric Group 3	CHELMBG3
Fabric Group 4	CHELMBG4

Prices include standard features only, see optional extras.

OPTIONAL EXTRAS

Optional Extras

Code

Chrome Frame	CF
Fixed T Arms	EA

BRANDON

A multipurpose chair which can be used across a variety of environments. Brandon comes in chrome cantilever, or 4-leg option, both with or without arms.



For colour fabric groups refer to page 186 and for fabric swatches see page 192.



BRANDON MEETING CHAIR, CANTILEVER FRAME

Standard Features

- Chrome cantilever frame
- Stackable to 5 chairs high
- Black outer back
- Black outer seat panel
- Optional black PU arms
- Max weight 109kg

Fabric Group	Code
Fabric Group 1	CHBRCLG1
Fabric Group 2	CHBRCLG2
Fabric Group 3	CHBRCLG3
Fabric Group 4	CHBRCLG4



BRANDON MEETING CHAIR, 4 LEG FRAME

Standard Features

- Chrome 4 leg frame
- Stackable to 5 chairs high
- Black outer back
- Black outer seat panel
- Optional black PU arms
- Max weight 109kg

Fabric Group	Code
Fabric Group 1	CHBRFLG1
Fabric Group 2	CHBRFLG2
Fabric Group 3	CHBRFLG3
Fabric Group 4	CHBRFLG4

OPTIONAL EXTRAS

Optional Extras	Code
Black PU Arms	EA

Brandon chairs are stackable with optional arms.

Why choose just one when you can have fun!



Nautical



Monochrome



Heathland



Circus



Spicy

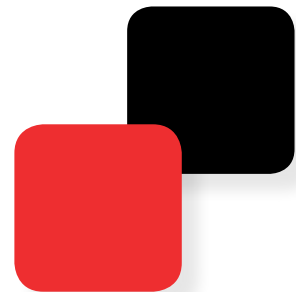

Dramatic



Vibrant Sky



Earthy



Moroccan Sunset

ELECT
POSEUR TABLES
Page 108



CAVIL
ARM CHAIRS
Page 168

ASHBY
HIGH STOOLS
Page 148

Which is best for you?

Bring fresh colour and style to your interior with our range of chairs and stools.



ASHBY

Our Ashby chairs have a distinctive design. Manufactured with a robust polypropylene seat and back, with a choice of different leg options and a selection of bright colours, this range will bring style and versatility to your interior.

The lightweight but rigid design is easy to maintain and clean, making it ideal for dining and breakout areas.



ASHBY CHAIRS AND HIGH STOOL ARE AVAILABLE IN:



BK Black



GY Grey



RE Red



NA Navy



GR Green



WH White



MU Mustard



TQ Turquoise



PL Plum

ORDERING

Select the code for the product you require and simply add the colour suffix option for example: CHASACBK

1 Year Guarantee.

W = Width, D = Depth, H = Height, SH = Seat Height



ASHBY CHAIR,
LEG STYLE A

Dimensions

W 580mm **D** 500mm **H** 810mm **SH** 450mm

Frame: Chrome **Stacking:** 4

Code

CHASAC



ASHBY CHAIR,
LEG STYLE B

Dimensions

W 560mm **D** 525mm **H** 810mm **SH** 450mm

Frame: Chrome **Stacking:** 4

Code

CHASBC



ASHBY CHAIR,
LEG STYLE C

Dimensions

W 510mm **D** 495mm **H** 810mm **SH** 450mm

Frame: Chrome

Code

CHASCC

ASHBY



Black



Beech

ASHBY CHAIR,
LEG STYLE K

Dimensions

W 505mm D 480mm H 810mm SH 450mm

Frame: Beech or Black

Frame	Code
Beech	CHASKBE
Black	CHASKB



ASHBY CHAIR,
LEG STYLE L

Dimensions

W 510mm D 480mm H 810mm SH 450mm

Frame: Swivel Black Powder Coated Steel

Code

CHASLB



ASHBY CHAIR,
LEG STYLE M

Dimensions

W 510mm D 480mm H 800mm SH 450mm

Frame: Black Steel

Code

CHASMB



ASHBY CHAIR,
LEG STYLE N

Dimensions

W 510mm D 480mm H 800mm SH 450mm

Frame: Chrome

Code

CHASNC



ASHBY CHAIR,
LEG STYLE P

Dimensions

W 510mm D 490mm H 810mm SH 450mm

Frame: Beech

Code

CHASPBE



ASHBY, HIGH STOOL

Dimensions

W 590mm D 500mm H 970mm SH 760mm

Frame: Chrome Stacking: 4

Code

CHASHSC

LINGWOOD

Our Lingwood chairs reference classic mid-century design, in modern and robust polypropylene. With a choice of leg styles, including mid and high stool options, the Lingwood range brings style and colour to your commercial interior.



LINGWOOD CHAIRS AND MID/HIGH STOOLS ARE AVAILABLE IN:



BK Black



GY Grey



RE Red



NA Navy



GR Green



WH White



MU Mustard



TQ Turquoise



PL Plum



A grey fabric upholstered option is also available.

GU Grey Fabric

1 Year Guarantee.

W = Width, **D** = Depth, **H** = Height, **SH** = Seat Height

ORDERING

Select the code for the product you require and simply add the colour suffix option for example: **CHLICCBK**



LINGWOOD CHAIR,
LEG STYLE C

Dimensions

W 450mm **D** 490mm **H** 830mm **SH** 450mm

Frame: Chrome

Code

CHLICC

CHLICCGU (**Grey Fabric**)



LINGWOOD CHAIR,
LEG STYLE E

Dimensions

W 480mm **D** 495mm **H** 820mm **SH** 450mm

Frame: Chrome

Stacking: 4

Code

CHLIEC

CHLIECGU (**Grey Fabric**)



LINGWOOD CHAIR,
LEG STYLE F

Dimensions

W 510mm **D** 510mm **H** 825mm **SH** 450mm

Frame: Chrome

Stacking: 4

Code

CHLIFC

CHLIFCGU (**Grey Fabric**)

LINGWOOD



Black

Beech

LINGWOOD CHAIR,
LEG STYLE K

Dimensions

W 460mm D 465mm H 835mm SH 450mm

Frame: Beech or Black

Frame

Code

Beech CHLIKBE

Black CHLIKB

Beech CHLIKBEGU
(Grey Fabric)

Black CHLIKBGU
(Grey Fabric)



LINGWOOD CHAIR,
LEG STYLE L

Dimensions

W 450mm D 490mm H 800mm SH 450mm

Frame: Swivel Black Powder Coated Steel

Code

CHLILB

CHLILBGU (Grey Fabric)



LINGWOOD CHAIR,
LEG STYLE M

Dimensions

W 510mm D 470mm H 800mm SH 450mm

Frame: Black Steel

Code

CHLIMB

CHLIMBGU (Grey Fabric)



LINGWOOD CHAIR,
LEG STYLE N

Dimensions

W 510mm D 470mm H 800mm SH 450mm

Frame: Chrome

Code

CHLINC

CHLINGU (Grey Fabric)



LINGWOOD CHAIR,
LEG STYLE P

Dimensions

W 490mm D 485mm H 810mm SH 450mm

Frame: Beech

Code

CHLIPBE

CHLIPBEGU (Grey Fabric)

LINGWOOD

Lingwood stylish stools are manufactured with a robust polypropylene seat and back, with a choice of two heights; a wooden frame mid stool or a modern chrome skid frame high stool. Perfect when paired with our NEW Sled Tall Table page 100.

LINGWOOD MID/HIGH STOOLS ARE AVAILABLE IN:



BK Black



GY Grey



RE Red



NA Navy



GR Green



WH White



MU Mustard



TQ Turquoise



PL Plum



A grey fabric upholstered option is also available.

GU Grey Fabric

1 Year Guarantee.

W = Width, **D** = Depth, **H** = Height, **SH** = Seat Height



LINGWOOD, MID HEIGHT STOOL

Dimensions

W 470mm **D** 485mm **H** 1065mm **SH** 680mm

Frame: Beech

Code

CHLIMSBE

CHLIMSBEGU (Grey Fabric)



LINGWOOD, HIGH STOOL

Dimensions

W 520mm **D** 540mm **H** 1130mm **SH** 760mm

Frame: Chrome

Stacking: 4

Code

CHLIHSC

CHLIHSCGU (Grey Fabric)



WROXHAM

Our new Wroxham armchairs are manufactured with a robust polypropylene seat and back in grey and white. A grey upholstered option is also available.

The classic colours and stylish leg options are ideal for foyer, reception and breakout areas.



WROXHAM CHAIRS ARE AVAILABLE IN:



GY Grey



WH White



GU Grey Fabric

A grey fabric upholstered option is also available.

ORDERING

Select the code for the product you require and simply add the colour suffix option for example: CHWRNCGY

1 Year Guarantee.

W = Width, **D** = Depth, **H** = Height, **SH** = Seat Height



Black

Beech

WROXHAM CHAIR, LEG STYLE K

Dimensions

W 580mm **D** 590mm **H** 850mm **SH** 450mm

Frame: Beech or Black

Frame	Code
Beech	CHWRKBE
Black	CHWRKB
Beech	CHWRKBEGU (Grey Fabric)
Black	CHWRKBGU (Grey Fabric)



WROXHAM CHAIR, LEG STYLE N

Dimensions

W 580mm **D** 575mm **H** 850mm **SH** 450mm

Frame: Chrome

Code

CHWRNC

CHWRNCGU (Grey Fabric)



WROXHAM CHAIR, LEG STYLE M

Dimensions

W 580mm **D** 575mm **H** 850mm **SH** 450mm

Frame: Black Steel

Code

CHWRMB

CHWRMBGU (Grey Fabric)

HOLT

Holt is a minimal style tub chair available with either a chrome skid frame or four leg frame finished in natural beech or black.

The Holt chair has an easy to clean polypropylene shell with a grey upholstered cushion. The stylish colour options and leg finishes provide an attractive contrast, giving the chairs a distinctive look that is ideal for foyer, reception and breakout areas.

HOLT CHAIRS ARE AVAILABLE IN:



BK Black



GY Grey



NA Navy



WH White

1 Year Guarantee.

W = Width, *D* = Depth, *H* = Height, *SH* = Seat Height

ORDERING

Select the code for the product you require and simply add the colour suffix option for example: CHHOCLBK



Beech

Black



HOLT CHAIR, 4 LEG

Dimensions

W 610mm **D** 570mm **H** 760mm **SH** 460mm

Frame: Beech Raw, Beech Clear Lacquer or Black

Frame

Code

Beech, Raw

CHHOFLR

Beech, Clear Lacquer

CHHOFLBE

Black

CHHOFLB

HOLT, SKID FRAME

Dimensions

W 570mm **D** 580mm **H** 735mm **SH** 450mm

Frame: Steel Rod Chrome Plated

Code

CHHOCLC

CARBROOKE

This simple and elegant chair is manufactured from polypropylene and is available in white, black or grey with beech legs.

The contemporary and durable design is easy to clean and maintain making it ideal for breakout and dining areas.

CARBROOKE CHAIRS ARE AVAILABLE IN:



BK Black



GY Grey



WH White

ORDERING

Select the code for the product you require and simply add the colour suffix option for example: **CHCABEWH**

1 Year Guarantee.

W = Width, D = Depth, H = Height, SH = Seat Height



CARBROOKE CHAIR

Dimensions

W 430mm **D** 480mm **H** 750mm **SH** 450mm

Frame: Beech

Stacking: 4

Code

CHCABE

HEYDON

A stylish chair featuring Swedish design and contrasting birch backs. Perfectly pairing comfort with distinctive form, Heydon chairs will raise the bar in any interior scheme.

The Heydon stool can be stacked for efficient use of space, and the sculptural design makes this an attractive and flexible addition to your seating provision.

CHOICE AND STYLE

- Four leg options including gas lift and mobile.
- Four seat options; with and without arms.
- Large and small stacking stools.
- Large choice of fabric options



Fully upholstered design allows single or mixed upholstery. For colour fabric groups **refer to page 190** and for fabric swatches **see page 192**

1 Year Guarantee.

HEYDON

CREATE YOUR CHAIR...

SEAT OPTIONS, CHAIR & ARMCHAIR

The Heydon is available with a birch back or as a fully upholstered chair.



Birch Back Chair
Without Arms



Birch Back Chair
With Arms



Fully Upholstered Chair
Without Arms



Fully Upholstered Chair
With Arms

4 LEG OPTIONS



Natural Wooden Legs



Skid Frame



4 Star Base – Gas Lift



Spider

HEYDON STOOLS

These sculptural, space efficient stacking stools will add colour to your interior space.

Available in two sizes and a wide range of fabric options.



ORDERING

Select the code for the product you require and simply add the fabric group code. Please refer to coding table, see right.



Fully upholstered design allows single or mixed upholstery. For colour fabric groups **refer to page 190** and for fabric swatches **see page 192**.

FABRIC GROUP CODING

Single & Seat/Inner Fabric Group	Code	Mixed Fabric Group	Code
Fabric Group 1	G1	Fabric Group 1	G1M
Fabric Group 2	G2	Fabric Group 2	G2M
Fabric Group 3	G3	Fabric Group 3	G3M
Fabric Group 4	G4	Fabric Group 4	G4M

W = Width, **D** = Depth, **H** = Height, **SH** = Seat Height

HEYDON

WOODEN LEGS



Dimensions:		W 600mm D 570mm H 850mm SH 450mm				
Heydon Chair	Birch Back, Chair (No Arms)	Birch Back, Armchair	Fully Upholstered, Chair (No Arms)		Fully Upholstered, Armchair	
Code	CHHE1FL	CHHE2FL	CHHE3FL		CHHE4FL	
	Seat/Inner Fabric	Seat/Inner Fabric	Single Fabric	Mixed Fabric	Single Fabric	Mixed Fabric

SKID FRAME

Features a Chrome wire skid frame.



Dimensions:		W 600mm D 570mm H 850mm SH 450mm				
Heydon Chair	Birch Back, Chair (No Arms)	Birch Back, Armchair	Fully Upholstered, Chair (No Arms)		Fully Upholstered, Armchair	
Code	CHHE1CS	CHHE2CS	CHHE3CS		CHHE4CS	
	Seat/Inner Fabric	Seat/Inner Fabric	Single Fabric	Mixed Fabric	Single Fabric	Mixed Fabric

ORDERING

Select the code for the product you require and simply add the fabric group code. Please refer to coding table, see right.



Fully upholstered design allows single or mixed upholstery. For colour fabric groups **refer to page 190** and for fabric swatches **see page 192**.

FABRIC GROUP CODING

Single & Seat/Inner Fabric Group	Code	Mixed Fabric Group	Code
Fabric Group 1	G1	Fabric Group 1	G1M
Fabric Group 2	G2	Fabric Group 2	G2M
Fabric Group 3	G3	Fabric Group 3	G3M
Fabric Group 4	G4	Fabric Group 4	G4M

W = Width, **D** = Depth, **H** = Height, **SH** = Seat Height

HEYDON

4 STAR BASE, GAS LIFT

Features a polished aluminium, rocking tilt mechanism and gas lift.



Dimensions:		W 600mm D 600mm H 850-990mm SH 450-590mm				
Heydon Chair	Birch Back, Chair (No Arms)	Birch Back, Armchair	Fully Upholstered, Chair (No Arms)		Fully Upholstered, Armchair	
Code	CHHE1ST	CHHE2ST	CHHE3ST		CHHE4ST	
	Seat/Inner Fabric	Seat/Inner Fabric	Single Fabric	Mixed Fabric	Single Fabric	Mixed Fabric

SPIDER LEGS

Features Chrome legs with 4 soft wheel chrome castors.



Dimensions:		W 600mm D 560mm H 850mm SH 460mm				
Heydon Chair	Birch Back, Chair (No Arms)	Birch Back, Armchair	Fully Upholstered, Chair (No Arms)		Fully Upholstered, Armchair	
Code	CHHE1MO	CHHE2MO	CHHE3MO		CHHE4MO	
	Seat/Inner Fabric	Seat/Inner Fabric	Single Fabric	Mixed Fabric	Single Fabric	Mixed Fabric

STACKING STOOLS



Large Stool



Small Stool

Stool	Dimensions	Code
Large	W 580 D 570 H 450	CHHEHS
Small	W 475 D 345 H 370	CHHELS

SOFT SEATING

Combining comfort with endurance, our soft seating ranges are designed to add lasting warmth and style to any interior. From standalone armchairs and sofas to modular units, as well as booths and stools, our soft seating offering is comprehensive and suited to all commercial interiors.

All of our Soft Seating is manufactured to a high specification and is available in large variety of colours and textures to blend with, or add accents to your scheme.

All seating is made to order and our team will be happy to advise on the most suitable product and configuration for your project.



SEATING CONFIGURATION

Our team are available to discuss your needs if you require assistance with seating configuration or space planning.

T: 01953 453830



STOOLS

Page 175

RAPID SEATING

Page 172

HIGHLIGHTS FROM OUR COLLECTION...



MOUNT MEDIA BOOTH

Shown in Xtreme Costa and Slip, with additional media table in birch.



CAVIL 2 SEATER SOFA

Shown in Xtreme Taboo.



DUAL SEAT UNITS

Shown in Xtreme Taboo and Slip.



RAPID SEAT UNIT

Shown in Xtreme Bridgetown and Costa.



AZUR ARMCHAIR

Shown in Xtreme Buru.

ORDERING

Select the code for the product you require and simply add the colour code from the fabric group you would like.



For colour fabric groups **refer to page 188** and for fabric swatches **see page 192.**

5 Year Guarantee

Fabric Guarantee as per manufacturer's instructions.

Please note, where fabric finishes have been selected from multiple group bands, the higher price band will be charged for the whole unit. If you require fabric to be treated for Fire Retardency, the fabric will move up to the next price band.

For any other queries or for assistance in selecting your products contact our friendly Customer Services team on **01953 453830**

MOUNT

With an angular design, accentuated by distinctive colour layering, Mount soft seating offers a large range of configurations and combinations. From chairs, sofas, stools and connecting units, to the media booth, the range is the perfect choice for flexibility and variety in any commercial interior.

FEATURES

- Polished Chrome corner feet
- Completely modular, any piece can be placed alongside another within the collection.
- Solid Beech frame construction.



For colour fabric groups **refer to page 188** and for fabric swatches **see page 192**.

W = Width, **D** = Depth, **H** = Height, **SH** = Seat Height

MOUNT, SMALL SEAT UNIT



Dimensions:	Fabric Group	Code
W 900mm	A	SEMOSSUA
D 700mm	B	SEMOSSUB
H 850mm	C	SEMOSSUC
SH 460mm	D	SEMOSSUD
	E	SEMOSSUE
	F	SEMOSSUF
	G	SEMOSSUG

MOUNT, LARGE SEAT UNIT



Dimensions:	Fabric Group	Code
W 1580mm	A	SEMOLSUA
D 700mm	B	SEMOLSUB
H 850mm	C	SEMOLSUC
SH 460mm	D	SEMOLSUD
	E	SEMOLSUE
	F	SEMOLSUF
	G	SEMOLSUG

MOUNT

MOUNT, 45° SEAT UNIT



Dimensions:	Fabric Group	Code
W 1085mm	A	SEMO45A
D 700mm	B	SEMO45B
H 850mm	C	SEMO45C
SH 460mm	D	SEMO45D
	E	SEMO45E
	F	SEMO45F
	G	SEMO45G

MOUNT, SMALL STOOL



Dimensions:	Fabric Group	Code
W 900mm	A	SEMOSSA
D 700mm	B	SEMOSSB
H 460mm	C	SEMOSSC
	D	SEMOSSD
	E	SEMOSS E
	F	SEMOSSF
	G	SEMOSSG

MOUNT, LARGE STOOL



Dimensions:	Fabric Group	Code
W 1580mm	A	SEMOLSA
D 700mm	B	SEMOLSB
H 460mm	C	SEMOLSC
	D	SEMOLSD
	E	SEMOLSE
	F	SEMOLSF
	G	SEMOLSG



A RANGE OF TABLES ARE AVAILABLE

Turn to page 94 to browse our Elect coffee tables to complement our seating range.

MOUNT

MOUNT, SINGLE CHAIR



Dimensions:	Fabric Group	Code
W 900mm	A	SEMOCHA
D 700mm	B	SEMOCHB
H 850mm	C	SEMOCHC
SH 460mm	D	SEMOCHD
	E	SEMOCHE
	F	SEMOCHF
	G	SEMOCHG

MOUNT, TWO SEATER SOFA



Dimensions:	Fabric Group	Code
W 1580mm	A	SEMOSOA
D 700mm	B	SEMOSOB
H 850mm	C	SEMOSOC
SH 460mm	D	SEMOSOD
	E	SEMOSOE
	F	SEMOSOF
	G	SEMOSOG

MOUNT, SINGLE SEAT BOOTH



Dimensions:	Fabric Group	Code
W 900mm	A	SEMOSBA
D 700mm	B	SEMOSBB
H 1630mm	C	SEMOSBC
SH 460mm	D	SEMOSBD
	E	SEMOSBE
	F	SEMOSBF
	G	SEMOSBG

MOUNT, TWO SEATER BOOTH



Dimensions:	Fabric Group	Code
W 1580mm	A	SEMOSBA
D 700mm	B	SEMOSBB
H 1630mm	C	SEMOSBC
SH 460mm	D	SEMOSBD
	E	SEMOSBE
	F	SEMOSBF
	G	SEMOSBG

MOUNT

MEDIA BOOTH



Dimensions:	Fabric Group	Code
W 2300mm	A	SEMOMBA
D 1580mm	B	SEMOMBB
H 1630mm	C	SEMOMBC
SH 460mm	D	SEMOMBD
	E	SEMOMBE
	F	SEMOMBF
	G	SEMOMBG

Two sofas with a depth of 700mm plus a 1000mm gap between each sofa.
TV Screen is shown for illustrative purposes only.
Power Module and Booth Table can be purchased separately.

OPTIONAL EXTRAS

Electronic devices can be connected, powered and recharged with a power module.
Add a table to your media booth with chrome leg and a choice of wood top finishes.

POWER MODULE



Colour	Code
Black, White, Grey	ACPMOD

Simply add the colour suffix to your code when ordering.
B Black **W** White **G** Grey

BOOTH TABLE



Code
ACTABS

ORDERING

The Media Booth Table has a chrome leg with a choice of wood top finishes. When ordering simply add the wood suffix to your code.

For example ACTABS**BI**

BE Beech, **LO** Light Oak, **MA** Maple, **BI** Birch,
WH White, **WA** Walnut



AZUR

The clean lines, and minimal polished chrome 'O' leg makes this professional and stylish range suitable to interiors where style and quality are key.



FEATURES

- Polished chrome 'O' leg.
- Completely square profile, allowing furniture to sit perfectly aligned.
- Solid Beech frame construction.
- A choice of fabric or leather upholstery.

W = Width, **D** = Depth, **H** = Height, **SH** = Seat Height



For colour fabric groups **refer to page 188** and for fabric swatches **see page 192**.

CUSHIONS

Cushions complement our Soft Seating ranges, adding colour and style as well as enhancing comfort. **See page 176 for more details.**



AZUR

AZUR, SINGLE ARMCHAIR



Dimensions:	Fabric Group	Code
W 830mm	A	SEAZCHA
D 830mm	B	SEAZCHB
H 830mm	C	SEAZCHC
SH 450mm	D	SEAZCHD
	E	SEAZCHE
	F	SEAZCHF
	G	SEAZCHG

AZUR, TWO SEATER SOFA



Dimensions:	Fabric Group	Code
W 1660mm	A	SEAZSOA
D 830mm	B	SEAZSOB
H 830mm	C	SEAZSOC
SH 450mm	D	SEAZSOD
	E	SEAZSOE
	F	SEAZSOF
	G	SEAZSOG

AZUR, BASE STOOL SMALL



Dimensions:	Fabric Group	Code
W 415mm	A	SEAZSSA
D 830mm	B	SEAZSSB
H 450mm	C	SEAZSSC
	D	SEAZSSD
	E	SEAZSSE
	F	SEAZSSF
	G	SEAZSSG

AZUR, BASE STOOL LARGE



Dimensions:	Fabric Group	Code
W 830mm	A	SEAZLSA
D 830mm	B	SEAZLSB
H 450mm	C	SEAZLSC
	D	SEAZLSD
	E	SEAZLSE
	F	SEAZLSF
	G	SEAZLSG

CAVIL

A more traditional Deco style range featuring polished chrome corner feet, rounded arms and featuring stitching detail to the back. Cavil offers comfort and style to complement any room layout.



CUSHIONS

Page 176

ELECT COFFEE TABLE

Page 108

FEATURES

- Polished chrome corner feet.
- Solid Beech frame construction.

W = Width, D = Depth, H = Height, SH = Seat Height



For colour fabric groups refer to page 188 and for fabric swatches see page 192.



CAVIL

CAVIL, SINGLE ARMCHAIR



Dimensions:	Fabric Group	Code
W 725mm	A	SECACHA
D 750mm	B	SECACHB
H 850mm	C	SECACHC
SH 460mm	D	SECACHD
	E	SECACHE
	F	SECACHF
	G	SECACHG

CAVIL, TWO SEATER SOFA



Dimensions:	Fabric Group	Code
W 1250mm	A	SECASOA
D 750mm	B	SECASOB
H 850mm	C	SECASOC
SH 460mm	D	SECASOD
	E	SECASOE
	F	SECASOF
	G	SECASOG

CAVIL, BASE STOOL



Dimensions:	Fabric Group	Code
W 525mm	A	SECASSA
D 525mm	B	SECASSB
H 460mm	C	SECASSC
	D	SECASSD
	E	SECASSE
	F	SECASSF
	G	SECASSG

CUSHIONS

Cushions complement our Soft Seating ranges, adding colour and style as well as enhancing comfort. **See page 176 for more details.**



AMITY

Shaping your open-plan space to create pockets of productivity, the Amity booth enables you to delineate working areas without creating closed environments. Booths are able to create a moment of privacy, encourage collaborative working, or enable break out working in situ.

The way we work is changing, and the introduction of booths into your commercial project will be a definitive step towards the future.



For colour fabric groups **refer to page 188** and for fabric swatches **see page 192**.

W = Width, **D** = Depth, **H** = Height, **SH** = Seat Height

FEATURES

- Create privacy in open plan areas.
- Polished chrome corner feet.
- Solid beech frame construction.
- Contrast fabric option.

AMITY, TALL SINGLE SEAT BOOTH



Dimensions:	Fabric Group	Code
W 810mm	A	SEAMTB1A
D 760mm	B	SEAMTB1B
H 1490mm	C	SEAMTB1C
SH 440mm	D	SEAMTB1D
	E	SEAMTB1E
	F	SEAMTB1F
	G	SEAMTB1G

AMITY, TALL TWO SEATER BOOTH



Dimensions:	Fabric Group	Code
W 1360mm	A	SEAMTB2A
D 760mm	B	SEAMTB2B
H 1490mm	C	SEAMTB2C
SH 440mm	D	SEAMTB2D
	E	SEAMTB2E
	F	SEAMTB2F
	G	SEAMTB2G

AMITY, LOW TWO SEATER BOOTH



Dimensions:	Fabric Group	Code
W 1360mm	A	SEAMLBA
D 760mm	B	SEAMLBB
H 1145mm	C	SEAMLBC
SH 440mm	D	SEAMLBD
	E	SEAMLBE
	F	SEAMLBF
	G	SEAMLBG



STOOLS

Page 175

AMITY, MEDIA BOOTH



Dimensions:	Fabric Group	Code
W 2520mm	A	SEAMMBA
D 1360mm	B	SEAMMBB
H 1490mm	C	SEAMMBC
SH 440mm	D	SEAMMBD
	E	SEAMMBE
	F	SEAMMBF
	G	SEAMMBG

TV Screen is shown for illustrative purposes only. Power Module and Booth Table can be purchased separately.

OPTIONAL EXTRAS

Electronic devices can be connected, powered and recharged with a power module. Add a table to your media booth with chrome leg and a choice of wood top finishes.

POWER MODULE



Colour	Code
Black, White, Grey	ACPMOD

Simply add the colour suffix to your code when ordering.
B Black **W** White **G** Grey

BOOTH TABLE



Code
ACTABS

ORDERING

The Media Booth Table has a chrome leg with a choice of wood top finishes. When ordering simply add the wood suffix to your code.

For example ACTABS**BI**

BE Beech, **LO** Light Oak, **MA** Maple, **BI** Birch, **WH** White, **WA** Walnut

RAPID

Our simple and compact Rapid range of modular seating is built to withstand the rigours of high traffic areas.

Offered in a selection of shapes, Rapid soft seating can be combined to make the very most of your available space.



For colour fabric groups **refer to page 188** and for fabric swatches **see page 192**.



W = Width, D = Depth, H = Height, SH = Seat Height

RAPID, SMALL SEAT UNIT



Dimensions:	Fabric Group	Code
W 600mm	A	SERPSSUA
D 650mm	B	SERPSSUB
H 800mm	C	SERPSSUC
SH 410mm	D	SERPSSUD
	E	SERPSSUE
	F	SERPSSUF
	G	SERPSSUG

RAPID, LARGE SEAT UNIT



Dimensions:	Fabric Group	Code
W 1200mm	A	SERPLSUA
D 650mm	B	SERPLSUB
H 800mm	C	SERPLSUC
SH 410mm	D	SERPLSUD
	E	SERPLSUE
	F	SERPLSUF
	G	SERPLSUG

RAPID, 45° SEAT UNIT



Dimensions:	Fabric Group	Code
W 950mm	A	SERP45A
D 650mm	B	SERP45B
H 800mm	C	SERP45C
SH 410mm	D	SERP45D
	E	SERP45E
	F	SERP45F
	G	SERP45G

RAPID

RAPID, SINGLE CHAIR



Dimensions:	Fabric Group	Code
W 700mm	A	SERPCHA
D 650mm	B	SERPCHB
H 800mm	C	SERPCHC
SH 410mm	D	SERPCHD
	E	SERPCH E
	F	SERPCH F
	G	SERPCH G

RAPID, TWO SEATER SOFA



Dimensions:	Fabric Group	Code
W 1300mm	A	SERPSOA
D 650mm	B	SERPSOB
H 800mm	C	SERPSOC
SH 410mm	D	SERPSOD
	E	SERPSOE
	F	SERPSOF
	G	SERPSOG



ELECT
COFFEE TABLE
Page 108

DUAL

Deceptively simple, the Dual seat and semi-circle units can be combined in many ways to create a seating area that is flexible and adaptable. Through the addition of contrast colours and our range of stools, you can easily create an impressive breakout area, or a well-furnished reception, whilst maintaining the option to change and reorganise at a moment's notice.



For colour fabric groups refer to page 188 and for fabric swatches see page 192.

Choose two large seat units and two semi circle units to create a dual seating bench.

W = Width, D = Depth, H = Height, SH = Seat Height

FEATURES

- Hardwood feet in Birch or Walnut.
- Solid Beech frame construction.

ORDERING

Dual seating is available with hardwood feet in Birch or Walnut.

To select your wood finish add either a **BI** Birch or **WA** Walnut.



DUAL, LARGE SEAT UNIT



Dimensions:	Fabric Group	Code
W 1100mm	A	SEDULSUA
D 650mm	B	SEDULSUB
H 790mm	C	SEDULSUC
SH 460mm	D	SEDULSUD
	E	SEDULSUE
	F	SEDULSUF
	G	SEDULSUG

DUAL, SEMI CIRCLE UNIT



Dimensions:	Fabric Group	Code
W 1300mm	A	SEDUSCA
D 600mm	B	SEDUSCB
H 460mm	C	SEDUSCC
	D	SEDUSCD
	E	SEDUSCE
	F	SEDUSCF
	G	SEDUSCG

STOOLS

Whether standalone or nesting, as impromptu seating or to complement your wider soft seating installation, our range of stools offer infinite combinations of colour and shape.

The Double Bite cut out stool is designed to link multiple circular stools.

CUBE STOOL



Dimensions:	Fabric Group	Code
Square 450mm	A	SECUBESTOOLA
Height 460mm	B	SECUBESTOOLB
	C	SECUBESTOOLC
	D	SECUBESTOOLD
	E	SECUBESTOOLE
	F	SECUBESTOOLF
	G	SECUBESTOOLG

CIRCULAR STOOL



Dimensions:	Fabric Group	Code
Square 450mm	A	SECIRCSTOOLA
Height 460mm	B	SECIRCSTOOLB
	C	SECIRCSTOOLC
	D	SECIRCSTOOLD
	E	SECIRCSTOOLE
	F	SECIRCSTOOLF
	G	SECIRCSTOOLG

DOUBLE BITE STOOL



Dimensions:	Fabric Group	Code
Square 450mm	A	SEBITESTOOLA
Height 460mm	B	SEBITESTOOLB
	C	SEBITESTOOLC
	D	SEBITESTOOLD
	E	SEBITESTOOLE
	F	SEBITESTOOLF
	G	SEBITESTOOLG



For colour fabric groups refer to page 197 and for fabric swatches see page 200.



See also our Heydon stools on page 159



CUSHIONS

To complement our soft seating range, or to freshen up your existing installation, our cushion selection can accentuate or accent your existing colour scheme. Enhancing interiors by offering additional comfort, colour and texture, cushions are the accessory that adds the finishing touch to your project.



CAVIL
2 SEATER SOFA
Page 168



For colour fabric groups **refer to page 188**
and for fabric swatches **see page 192.**

Try different colour combinations to brighten your interior.

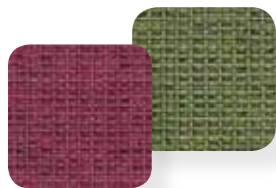

Gravity Evergreen and Petal



Canopy Yellowl, Tulip and Grey



Phoenix Parasol, Olympic and Costa

CUSHIONS

SMALL SQUARE SCATTER CUSHION



Dimensions:	Fabric Group	Code
W 400mm	A	SQSCUSHA
D 150mm	B	SQSCUSHB
H 400mm	C	SQSCUSHC
	D	SQSCUSHD
	E	SQSCUSHE
	F	SQSCUSHF
	G	SQSCUSHG

LARGE SQUARE SCATTER CUSHION



Dimensions:	Fabric Group	Code
W 500mm	A	SQLCUSHA
D 200mm	B	SQLCUSHB
H 500mm	C	SQLCUSHC
	D	SQLCUSHD
	E	SQLCUSHE
	F	SQLCUSHF
	G	SQLCUSHG

ROUND BOLSTER SCATTER CUSHION



Dimensions:	Fabric Group	Code
W 500mm	A	ROUCUSHA
Round 200mm	B	ROUCUSHB
	C	ROUCUSHC
	D	ROUCUSHD
	E	ROCUSHE
	F	ROCUSHF
	G	ROCUSHG

BOXED SCATTER CUSHION



Dimensions:	Fabric Group	Code
W 540mm	A	BOXCUSHA
D 200mm	B	BOXCUSHB
H 370mm	C	BOXCUSHC
	D	BOXCUSHD
	E	BOXCUSHE
	F	BOXCUSHF
	G	BOXCUSHG

SCREENS

Desk mounted screens help to define personal space while adding an attractive splash of colour to your office environment.

For all Duty screens please turn to pages 45 – 47.

EXECUTIVE SCREENS

Executive screens come with a silver or white toolrail with matching trim and have the ability to be linked together where required. Available in a variety of fabric choices.

FABRICS

Choose from a variety of color fabrics from either the Camira Cara, Carlow or Lucia range.

Camira	
Group 1	Group 2
Cara, Carlow	Lucia



Fabric 100% polyester, Non metallic dyestuffs.

Abrasion Tested in accordance with BS 5690:1991 as modified by Annex F of BS 2543:1995 to 50,000 rubs Martindale.

Fire Retardancy Vertical surface test BS 476 Part 7 Class 1. BS EN 1021 - 1&2:1994 BS 5852 (passes Cigarette and match)

Note: Flammability performance is dependent on components used.

Light Fastness 6+ (ISO 105 - B02:1999)

PERSPEX SCREENS

Available in a choice of 4 colours; Frosted White, Clear, Green or Blue.

Alternative options are available upon request.

Perspex screens are available in 3 shapes; rectangular, wave or curve.

Screens are made from 5mm translucent perspex.

FINISHES



CL Clear



FW Frosted
White



G Green



BL Blue

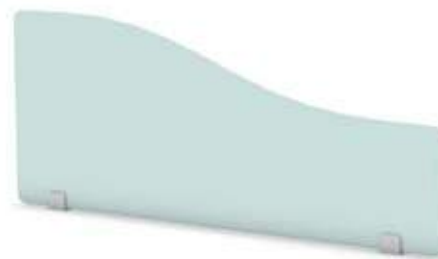

STANDARD SCREENS

Available in a variety of fabric choices and 3 shapes; rectangular, wave or curve.

Screens can be fitted in the centre of a cluster of desks if required.

Fabric 100% Non metallic dyestuffs.

Abrasion Tested in accordance with BS 5690:1991 as modified by Annex F of BS 2543:1995 to 40,000 rubs Martindale.

Fire Retardancy Vertical surface test BS 476 Part 7 Class 1. BS EN 1021 - 1:1994 (Cigarette)

Note: Flammability performance is dependent on components used.

Light Fastness 6+ (ISO 105 - B02:1999)

FABRICS

Available in a choice of 4 standard fabric colours: Black, Blue, Ruby Red or Grey.



BK Black



BL Blue



RB Ruby



GY Grey



Standard fabrics



Alternative colour options are available from the Camira Cara, Carlow or Lucia range.

SCREENS

EXECUTIVE SCREENS

Executive screens are available in a variety of fabric choices, with an option of **(S)** silver or **(W)** white toolrail and matching trim.

Fabrics: Group 1 fabrics from the Camira Cara or Carlow range.
Group 2 fabrics from the Camira Lucia range.



For colour fabric swatches **refer to page 194**.
For more colour options visit
www.camirafabrics.com/contract

ORDERING – EXECUTIVE

Select the code for the product you require and simply add the Camira fabric code you would like.
To select your toolrail and trim add **S** Silver or **W** White.

*Please note: Screens not compatible with Duty.
For Duty Executive screens, please turn to pages 47.*

SINGLE / TRIPLE TOOLRAIL



Single Toolrail



Triple Toolrail

W x H (mm)	Description	Single Group 1	Single Group 2	Triple Group 1	Triple Group 2
380mm High					
600 x 380	Fits to 600mm wide desk or desk return	SC3T36G1	SC3T36G2	SC3TR36G1	SC3TR36G2
800 x 380	Fits to 800mm wide desk or desk return	SC3T38G1	SC3T38G2	SC3TR38G1	SC3TR38G2
1000 x 380	Fits to 1000mm wide desk or desk return	SC3T310G1	SC3T310G2	SC3TR310G1	SC3TR310G2
1200 x 380	Fits to 1200mm wide desk	SC3T312G1	SC3T312G2	SC3TR312G1	SC3TR312G2
1400 x 380	Fits to 1400mm wide desk	SC3T314G1	SC3T314G2	SC3TR314G1	SC3TR314G2
1600 x 380	Fits to 1600mm wide desk	SC3T316G1	SC3T316G2	SC3TR316G1	SC3TR316G2
1800 x 380	Fits to 1800mm wide desk	SC3T318G1	SC3T318G2	SC3TR318G1	SC3TR318G2
400mm High					
600 x 480	Fits to 600mm wide desk or desk return	SC4T36G1	SC4T36G2	SC4TR36G1	SC4TR36G2
800 x 480	Fits to 800mm wide desk or desk return	SC4T38G1	SC4T38G2	SC4TR38G1	SC4TR38G2
1000 x 480	Fits to 1000mm wide desk or desk return	SC4T310G1	SC4T310G2	SC4TR310G1	SC4TR310G2
1200 x 480	Fits to 1200mm wide desk	SC4T312G1	SC4T312G2	SC4TR312G1	SC4TR312G2
1400 x 480	Fits to 1400mm wide desk	SC4T314G1	SC4T314G2	SC4TR314G1	SC4TR314G2
1600 x 480	Fits to 1600mm wide desk	SC4T316G1	SC4T316G2	SC4TR316G1	SC4TR316G2
1800 x 480	Fits to 1800mm wide desk	SC4T318G1	SC4T318G2	SC4TR318G1	SC4TR318G2

SCREENS

PERSPEX SCREENS

Available in a choice of 4 colours: Clear, Frosted White, Green or Blue.



CL Clear



FW Frosted
White



G Green



BL Blue

Alternative options are available upon request.

ORDERING – PERSPEX

Select the code for the product you require and simply add the colour suffix to your code when ordering

For example SCPX8RCL

CL Clear, **FW** Frosted White, **G** Green, **BL** Blue

PERSPEX SCREENS



Rectangular

Height varies
380mm to
180mm



Wave

Height varies
380mm to
180mm



Curve

W x H (mm)	Description	Rectangular	Wave	Curve
800 x 380	Fits to 800mm wide desk or desk return	SCPX8R	SCPX8W	SCPX8A
1000 x 380	Fits to 1000mm wide desk or desk return	SCPX10R	SCPX10W	SCPX10A
1200 x 380	Fits to 1200mm wide desk or desk return	SCPX12R	SCPX12W	SCPX12A
1400 x 380	Fits to 1400mm wide desk	SCPX14R	SCPX14W	SCPX14A
1600 x 380	Fits to 1600mm wide desk	SCPX16R	SCPX16W	SCPX16A
1800 x 380	Fits to 1800mm wide desk	SCPX18R	SCPX18W	SCPX18A



SCREENS

STANDARD SCREENS

Please note: Screens not compatible with Duty.
For Duty Standard screens, please turn to pages 45 – 46.

Available in a choice of 4 standard fabric colours and 3 shapes.



ORDERING – STANDARD

Select the code for the product you require and simply add the colour suffix to your code when ordering.

For example SCBS8RBK

BK Black, **RB** Ruby, **BL** Blue, **GY** Grey

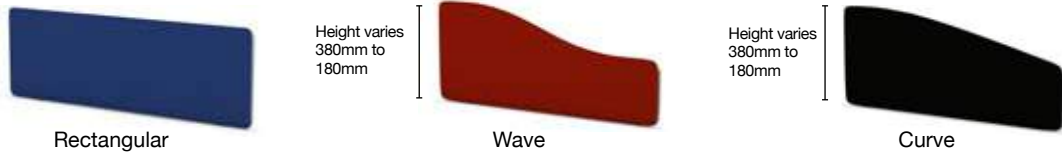

W x H (mm)	Description	Rectangular	Wave	Curve
800 x 380	Fits to 800mm wide desk or desk return	SCBS80R	SCBS80W	SCBS80A
1000 x 380	Fits to 1000mm wide desk or desk return	SCBS10R	SCBS10W	SCBS10A
1200 x 380	Fits to 1200mm wide desk or desk return	SCBS12R	SCBS12W	SCBS12A
1400 x 380	Fits to 1400mm wide desk	SCBS14R	SCBS14W	SCBS14A
1600 x 380	Fits to 1600mm wide desk	SCBS16R	SCBS16W	SCBS16A
1800 x 380	Fits to 1800mm wide desk	SCBS18R	SCBS18W	SCBS18A

Alternative colours are available from the Camira Cara, Carlow or Lucia range.

Fabrics: Group 1 fabrics from the Camira Cara or Carlow range.
Group 2 fabrics from the Camira Lucia range.



For colour fabric swatches refer to page 194.
For more colour options visit
www.camirafabrics.com/contract

ORDERING – FABRIC GROUPS

Select the code for the product you require and simply add the Camira fabric code.

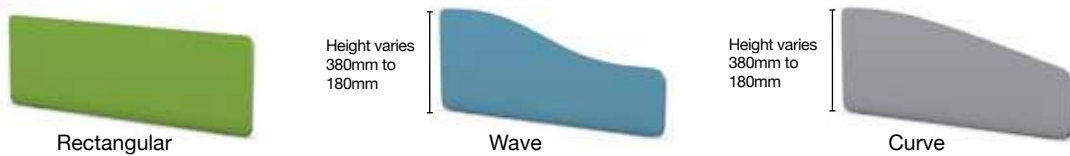

W x H (mm)	Description	Rectangular	Wave	Curve
Group 1 fabrics				
800 x 380	Fits to 800mm wide desk or desk return	SCBS80RG1	SCBS80WG1	SCBS80AG1
1000 x 380	Fits to 1000mm wide desk or desk return	SCBS10RG1	SCBS10WG1	SCBS10AG1
1200 x 380	Fits to 1200mm wide desk or desk return	SCBS12RG1	SCBS12WG1	SCBS12AG1
1400 x 380	Fits to 1400mm wide desk	SCBS14RG1	SCBS14WG1	SCBS14AG1
1600 x 380	Fits to 1600mm wide desk	SCBS16RG1	SCBS16WG1	SCBS16AG1
1800 x 380	Fits to 1800mm wide desk	SCBS18RG1	SCBS18WG1	SCBS18AG1
Group 2 fabrics				
800 x 380	Fits to 800mm wide desk or desk return	SCBS80RG2	SCBS80WG2	SCBS80AG2
1000 x 380	Fits to 1000mm wide desk or desk return	SCBS10RG2	SCBS10WG2	SCBS10AG2
1200 x 380	Fits to 1200mm wide desk or desk return	SCBS12RG2	SCBS12WG2	SCBS12AG2
1400 x 380	Fits to 1400mm wide desk	SCBS14RG2	SCBS14WG2	SCBS14AG2
1600 x 380	Fits to 1600mm wide desk	SCBS16RG2	SCBS16WG2	SCBS16AG2
1800 x 380	Fits to 1800mm wide desk	SCBS18RG2	SCBS18WG2	SCBS18AG2

ACCESSORIES



(Unless Specified)

Whether specifying a new interior, or refurbishing an existing work space, accessories are the little extras that make all the difference. Tidy away cables, or tidy away desk top clutter with a screen arm and a drawer tray. Or simply give everything a face lift with matching handles.

PEDESTAL ACCESSORIES

ADJUSTABLE PEN TRAY



Description	Range	Colour	Code
Single	All wooden Pedestals	Black	ATPTRAYS

PEN TRAYS, LIGHT GREY

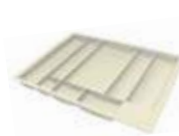

Description	Range	Code
Single	AuraBench, Atmosphere & DominoBeam	SAPTRAY1LG
Pack of 5	AuraBench, Atmosphere & DominoBeam	SAPTRAY5SY

PEN TRAYS, DARK GREY



Description	Range	Code
Single	All *	ACPTRAY1DG
Pack of 5	All *	ACPTRAY5

* Not applicable to AuraBench, Atmosphere and DominoBeam.

BOW HANDLES



Description	Range	Colour	Code
Pack of 10	All	Silver	ACBOWS

MOSAIC HANDLES



Description	Range	Colour	Code
Pack of 10	All	Silver	ACMOSAICS

MATRIX HANDLES



Description	Range	Colour	Code
Pack of 10	All	Silver	ACMATRIXS

OVAL HANDLES



Description	Range	Colour	Code
Pack of 10	All	Silver	ACOVALS

BAR HANDLES



Description	Range	Colour	Code
Pack of 10	All	Silver	ACBARS

MONITOR ARMS

An ergonomic monitor arm provides practical benefits and enhances the visual appeal of your installation.

5 Year Guarantee on all monitor arms.

POLE MOUNTED, SINGLE



Description	Colour	Code
-------------	--------	------

Pole mounted monitor arm for single screen, with quick release height adjustment and detachable VESA plate.

Black, Silver & White

ACMONARMSPM

Simply add the colour suffix to your code when ordering.
B Black S Silver W White

POLE MOUNTED, TWIN



Description	Colour	Code
-------------	--------	------

Pole mounted monitor arm for twin screen, with quick release height adjustment and detachable VESA plate.

Black, Silver & White

ACMONARMTPM

Simply add the colour suffix to your code when ordering.
B Black S Silver W White

SCREEN MOUNTED, SINGLE



Description	Colour	Code
-------------	--------	------

Desk screen mounting pole mounted monitor arm for single screen, with quick release height adjustment and detachable VESA plate.

Black, Silver & White

ACMONARMSCP

Simply add the colour suffix to your code when ordering.
B Black S Silver W White

GAS LIFT, SINGLE



Description	Colour	Code
-------------	--------	------

Gas lift slimline single monitor arm, desk clamp tightens from above desk, fully cable managed, removable VESA head.

Black, Silver & White

ACMONARMSDC

Simply add the colour suffix to your code when ordering.
B Black S Silver W White

GAS LIFT, DUAL



A fixing to single monitor arm

Description	Colour	Code
-------------	--------	------

Gas lift dual screen rail with quick release fixing to single monitor arm, universal 75mm VESA compatibility with all other monitor arms.
Single monitor arm not included in price.

Black

ACMONARMDUALSRB

LAPTOP HOLDER



Description	Colour	Code
-------------	--------	------

Universal laptop holder for fixing to standard 75 / 100mm VESA fittings.

Silver & White

ACLAPHOLD

Simply add the colour suffix to your code when ordering.
S Silver W White

CABLE MANAGEMENT

VERTICAL CABLE MANAGER



Description	Colour	Code
-------------	--------	------

V1 Vertical Cable Manager.
5 Year Guarantee. Black, Silver & White ACCVSPINE

Simply add the colour suffix to your code when ordering.
B Black S Silver W White

SLINKY CABLE MANAGER



(3 week lead time)

Description	Colour	Code
-------------	--------	------

Slinky Cable Manager Black, Silver & White ACCMSLINKY

Simply add the colour suffix to your code when ordering.
B Black S Silver W White

CABLE TRUNKING

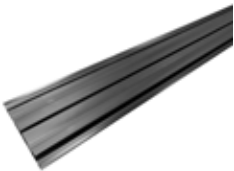

Description	Colour	Code
-------------	--------	------

Plastic cable trunking to neatly conceal wires.
2 x 2.5 metre lengths included. Anthracite ACCTRUNK
Self adhesive to secure to surfaces.

WIRE MESH CABLE TRAYS



Description	Colour	Code
-------------	--------	------

Suitable for 1000mm desk Chrome ACMESH10

Suitable for 1200mm desk Chrome ACMESH12

Suitable for 1400mm desk Chrome ACMESH14

Suitable for 1600mm desk Chrome ACMESH16

Suitable for 1800mm desk Chrome ACMESH18

5 Year Guarantee on wire mesh cable trays.

GANG SOCKET



Description	Colour	Code
-------------	--------	------

2 Socket with switches. Black ACSOCKET2

3 Sockets, no switches. Black ACSOCKET3

4 Sockets, no switches. Black ACSOCKET4

MAINS CABLE



Description	Colour	Code
-------------	--------	------

3 Metre length Black ACMAINCAB3

5 Metre length Black ACMAINCAB5

7 Metre length Black ACMAINCAB7

CPU HOLDERS

CPU HOLDER 01



Description

C3 large CPU holder for fixing to desk top, adjustable in W 80 – 220mm, H 300 – 530mm.
5 Year Guarantee.

*Simply add the colour suffix to your code when ordering.
B Black S Silver W White*

Colour

Black,
Silver &
White

Code

ACCPUHOLDL

CPU HOLDER 02



Description

C6 universal adjustable belt CPU holder for fixing under the desk top.

5 Year Guarantee.

Colour

Black

Code

ACCPUHOLDUNIB

MICRO CPU HOLDER



Description

Ideal for mini CPUs. Can be fitted to pole or arm, allows easy access to ports. Can also be fixed to any part of the desk. Fully adjustable for different CPU sizes.

5 Year Guarantee.

*Simply add the colour suffix to your code when ordering.
B Black S Silver W White*

Colour

Black,
Silver &
White

Code

ACCPUHOLDM

CPU UNIT



Description

L342 x D600 x H665mm.

Colour

Beech

Code

ACCPUNIT

CPU TROLLEY



Description

L555 x D204 x H80mm.

Colour

Beech

Code

ACCPUTROL

PORT HOLES

(3 week lead time)



Port Hole – Black, Grey and White

Description	Colour	Code
Port Hole <ul style="list-style-type: none"> 1 x Power socket and 1m mains cable Power socket 3.15A individually fused with 1m mains cable to 3 pin connector Easy to retrofit, incorporates an under desk, hand tightened barrel nut to fix unit in place. All power and data cables exit from the base of the unit. 	Black Grey White	ACPORTSOCKBK ACPORTSOCKGY ACPORTSOCKWH
Port Hole with USB Socket <ul style="list-style-type: none"> 1 x Power socket, 1 x USB socket, 1m mains cable, 2m USB lead Power socket 3.15A individually fused with 1m mains cable to 3 pin connector and 2m USB lead. Easy to retrofit, incorporates an under desk, hand tightened barrel nut to fix unit in place. All power and data cables exit from the base of the unit. 	Black Grey White	ACPORTUSBBK ACPORTUSBGY ACPORTUSBWH
Power Hole with RJ45 Cat6 Socket <ul style="list-style-type: none"> 1 x Power socket, 1 x RJ45 Cat6 socket, 1m mains cable, 3m data lead Power socket 3.15A individually fused with 1m mains cable to 3 pin connector with 3m data lead. Easy to retrofit, incorporates an under desk, hand tightened barrel nut to fix unit in place. All power and data cables exit from the base of the unit. 	Black, Grey White	ACPORTRJ45BK ACPORTRJ45GY ACPORTRJ45WH

Port holes fit desks fitted with round cable ports. Port holes feature individual fuse and are independently certified to BS 5733.



FABRIC GROUPS

TASK & MEETING CHAIRS

Camira			
Group 1	Group 2	Group 3	Group 4
Advantage	Canopy	Aspect	Aquarius
Citadel	Chateau	Figaro	Blazer
Era	Manhattan	Halcyon - Linden	Halcyon - Aspen
Gravity	Mainline	Honeycomb	Halcyon - Blossom
Phoenix	Sprint	Mainline Flax	Halcyon - Ceder
Rivet	Urban	Nexus	Halcyon - Poplar
	Velocity Mesh	Patina	Hebden & Hemp Plus
	Pu Torro	Xtreme CS	Hi-Tech
	Vita		Intervene
	X2		Landscape Collection
	Xtreme Plus		Marvel
			Oxygen
			Silk
			Synergy
			Track
			Trail
			24/7
			24/7 Flax

FABRIC GROUPS

TASK & MEETING CHAIRS

Chieftain (Vinyl Fabric)			
Group 1	Group 2	Group 3	Group 4
	Pu Trimcell Classic		Just Colour
Gabriel			
Group 1	Group 2	Group 3	Group 4
	Dragon	Atlantic	
	Event	Fighter	
	String	Grace	
		Harlequin	
		Medley	
		Step	
Panaz			
Group 1	Group 2	Group 3	Group 4
		Highland	Alcazar
		Microvelle	Harvard
		Linear	Vespa
		Myriad	Crisp
		Pu Ultimate Touch	Fame
		Pu Cadet Colours	Flex
			Infinity
			Interglobe Wool 2
			Monment
			Nova 2
			Omega
			Runner
			Step Melange

Leather and other ranges price on application.

Guarantee

For 8 hours per day use all models have 5 Year Guarantee on all chairs and 2 year guarantee on moving parts.

For 24 hour per day use a structural guarantee applies.

Fabric Guarantee as per manufacturer instructions.

A selection of our most popular colour fabrics shown. For more colour options visit www.camirafabrics.com/contract

FABRIC GROUPS

SOFT SEATING

Camira						
Group A	Group B	Group C	Group D	Group E	Group F	Group G
Advantage	Canopy	Aspect	24/7	Acrobat (Net)	Blazer - Hourglass	Leather
Citadel	Chateau Plus	Halcyon - Linden	24/7 Flax	Century	Blazer - Quilt	
Era	Figaro	Honeycomb	Aquarius	Code	Corrosion	
Gravity	Mainline Plus	Mainline Flax	Blazer	Craggan	Nettle Collection	
Phoenix	Manhattan	Marvel	Halcyon - Aspen	Craggan Flax	Synergy - Chevron	
Rivet	Sprint	Patina	Halcyon - Blossom	Individuo	Synergy - Hourglass	
	Urban Plus		Halcyon - Ceder	Stripes	Synergy - Quilt	
	Velocity		Halcyon - Poplar	Trail	Vintage	
	Vita		Hebden & Hemp		Zig Zag	
	Xtreme Plus		Hi-Tech			
	X2		Intervene			
			Landscape			
			Mainline Flax Stripe			
			Oxygen			
			Silk			
			Synergy			
			Track			
Agua						
Group A	Group B	Group C	Group D	Group E	Group F	Group G
	Juno	Aura	7 Collection			
	Libra	Cashmir	Alberta			
	Linetta	Furnisoft	Mystique			
	Lunar	Fusion	Oregon			
	Paint Pot	Nova	Stretch			
		Ocular				
		Parody				
		Snowdon				
		Stirata				
		Taurus				
		Vistas				
Chieftain (Vinyl Fabric)						
Group A	Group B	Group C	Group D	Group E	Group F	Group G
	Carino					
	Just Colour					
	Just Pattern					

FABRIC GROUPS

SOFT SEATING

Crest Leather						
Group A	Group B	Group C	Group D	Group E	Group F	Group G
						Leather
Lexaire						
Group A	Group B	Group C	Group D	Group E	Group F	Group G
						Leather
Classic						
Paintbox						
Plus						
Panaz						
Group A	Group B	Group C	Group D	Group E	Group F	Group G
		Cadet Colours	Altair	Binary Age		
		Haven	Aston	Digital Age		
		Lush	Brookland	Gridz		
		Marna	Calroust	Harvard		
		Myraid	Coco	Isla		
			Darcy	Lara		
			Eve	Oasis		
			Highland	Patternistas		
			Linear	Rhona		
			Mircrovelle	Shapes		
			Montagu	Tessellate		
			Morgan	Vespa		
			Portman			
			Soho			
			Soft Touch			
			Ultimate Touch			
Yarwood						
Group A	Group B	Group C	Group D	Group E	Group F	Group G
						Leather

Please note where fabric finishes have been selected from multiple group bands, the higher price band will be charged for the whole unit.

If you require fabric to be treated for Fire Retardency, the fabric will move up to the next price band.

All of our Soft Seating comes with a **5 Year Guarantee** (Fabric guarantee as per manufacturer’s instructions).

To ensure your fabric choice meets the needs of your commercial interior and for technical specification and fabric guarantees, please visit www.camirafabrics.com/contract

For any other queries or for assistance in selecting your products contact our friendly Customer Services team on **01953 453830**

A selection of our most popular colour fabrics shown. For more colour options visit www.camirafabrics.com/contract

FABRIC GROUPS

HEYDON

Camira				
Group 1	Group 2	Group 3	Group 4	
Advantage	Chateau +	Oxygen	Craggan	
Xtreme	Mainline + & Flax	24/7.	Hebden +	
Manhattan	Urban +	Intervene +		
Gravity	Aquarius	Hemp		
X2	Blazer	Marvel		
Canopy	Sprint	Synergy		
	Vita			

Kvadrat				
Group 1	Group 2	Group 3	Group 4	
	Umami	Pause 4	Cava 3	Remix 2
			Divina 3	Plot
			Field	Steelcut Trio 2
			Flora 2	Clara

Macflex				
Group 1	Group 2	Group 3	Group 4	
Oporto	Porus	Durius		
	Savanna	Polo		
	Delta/Syntec	Ostrich		
	Sintra			

Gabriel				
Group 1	Group 2	Group 3	Group 4	
Event	Digital 2	Fame	Step Melange	
	Fighter	Atlantic	Charisma	
	Europost	Step	Flex	
	Gaja Classic	Nova 2		
	Argos 2	Europost 2		

Sunbury				
Group 1	Group 2	Group 3	Group 4	
			Laiqu	

John Tate				
Group 1	Group 2	Group 3	Group 4	
	Just Colour	Ambla		

Panaz				
Group 1	Group 2	Group 3	Group 4	
		Aston		

Agua				
Group 1	Group 2	Group 3	Group 4	
	Libra	Evoke	Aura Stripe	Derrytex
	Lunra	Juno	Mystique	
	Paint Pot	Linetta	7 Collection	
	Aries	Nova		
	Aura	Sirata		
	Cashmir	Taurus		
	Classic			

FABRIC GROUPS

HEYDON

Vescom			
Group 1	Group 2	Group 3	Group 4
	Furka Plus	Samar	Yuma
	Leone Plus		Lami
	Cres		Ariana

J Singleton			
Group 1	Group 2	Group 3	Group 4
	Just Colour	Ambla	

Spectrum			
Group 1	Group 2	Group 3	Group 4
	Colour Pallett		Piccadilly
	Metallics		

CTP			
Group 1	Group 2	Group 3	Group 4
	Valencia		

Ultra Leather			
Group 1	Group 2	Group 3	Group 4
		Ultra Leather	

Bute			
Group 1	Group 2	Group 3	Group 4
		Kilmory	Clyde
			Elgin
			Pentland
			Ramshead
			Rosslyn
			Stuart Tartan
			Argyll
			Braemar
			Esk
			Heathered Tweed
			Iona
			Kames
			Lewis
			Melrose
			New Selkirk
			Skye
			Storr
			Tay
			Troon
			Turnberry
			Tuitti Fruitti Tweed
			Tweed

SCREENS

EXECUTIVE / STANDARD SCREENS

Camira	
Group 1	Group 2
Cara, Carlow	Lucia

STANDARD SCREENS

Are available in a choice of 4 standard fabric colours: Black, Blue, Ruby Red or Grey on Quick Ship Delivery.



BK Black



BL Blue



RB Ruby



GY Grey



FABRIC SWATCHES

SEATING

GROUP 1 / A

PHOENIX

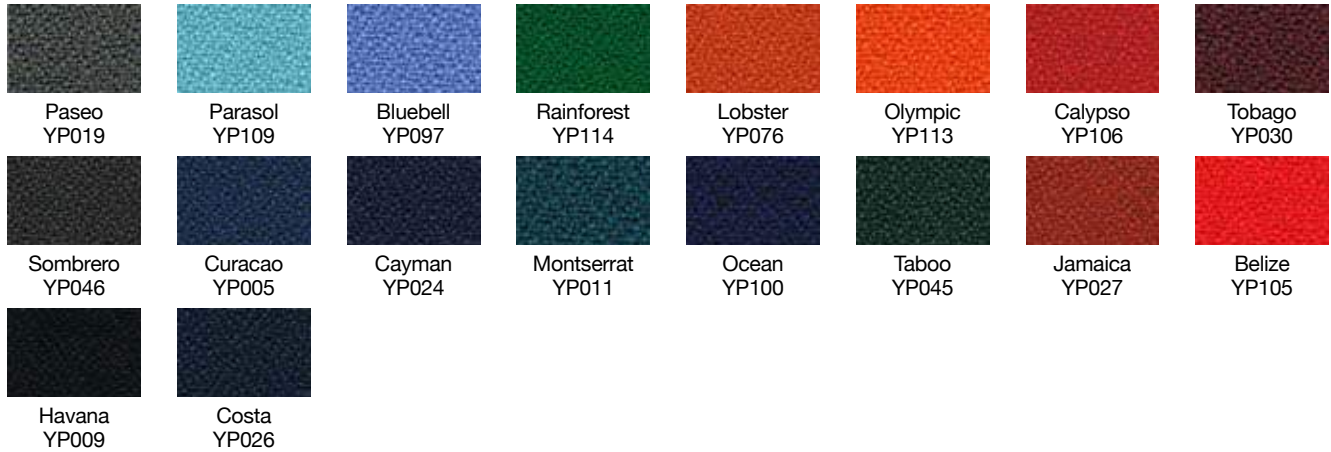

ADVANTAGE

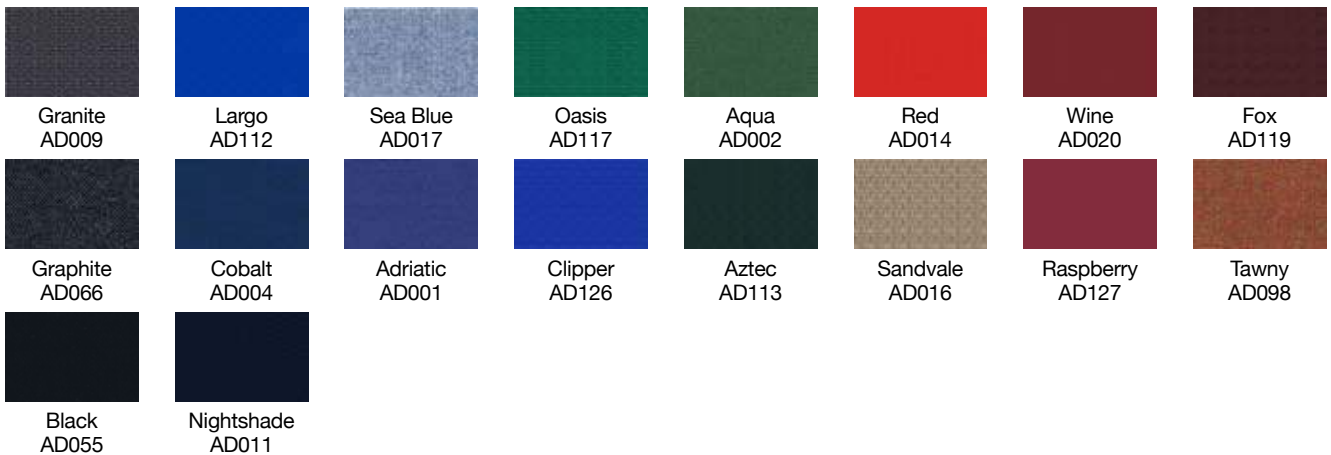

GRAVITY

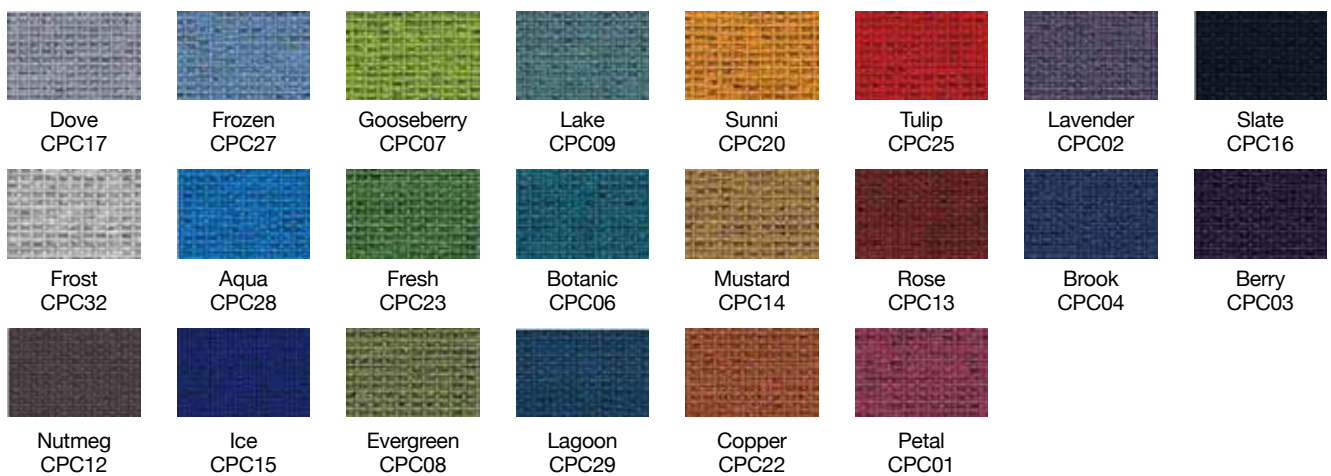

A selection of our most popular colour fabrics shown. For more colour options visit www.camirafabrics.com/contract
Swatches shown are for illustration only, colour may vary.

FABRIC SWATCHES

SEATING

GROUP 2 / B - (HEYDON GROUP 1)

XTREME

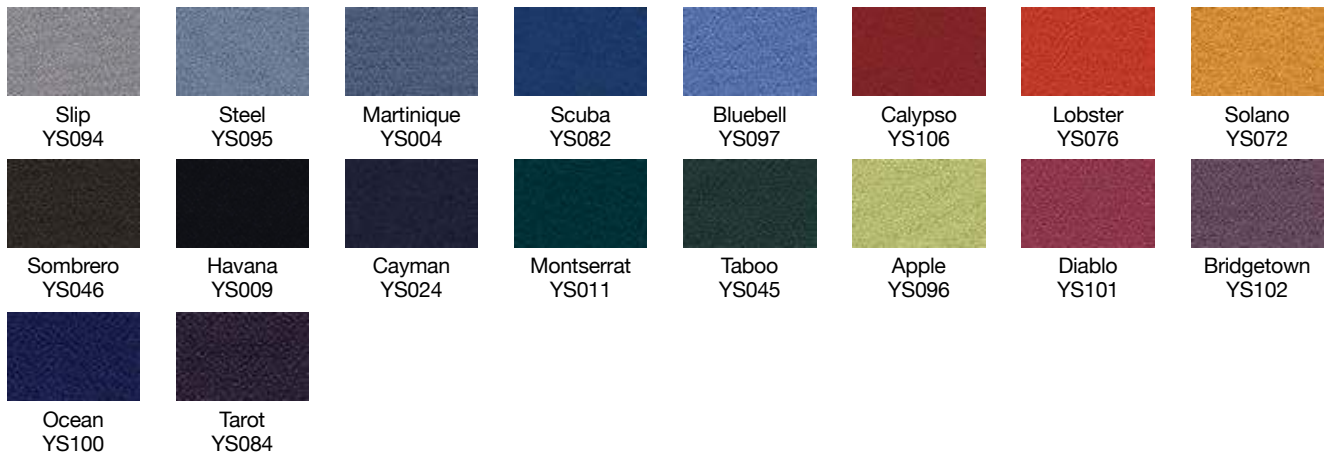

CANOPY

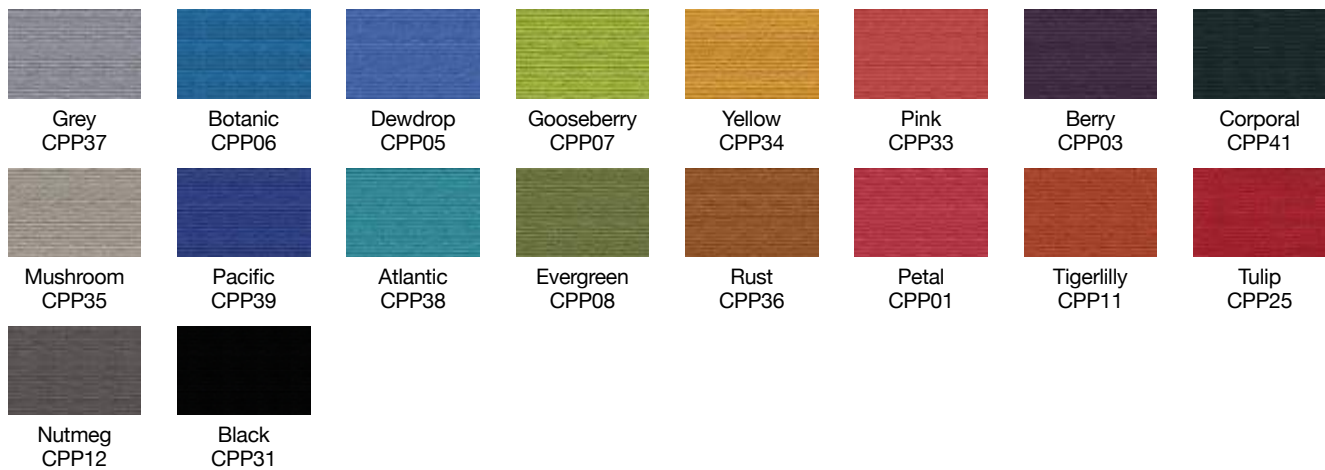

MANHATTAN

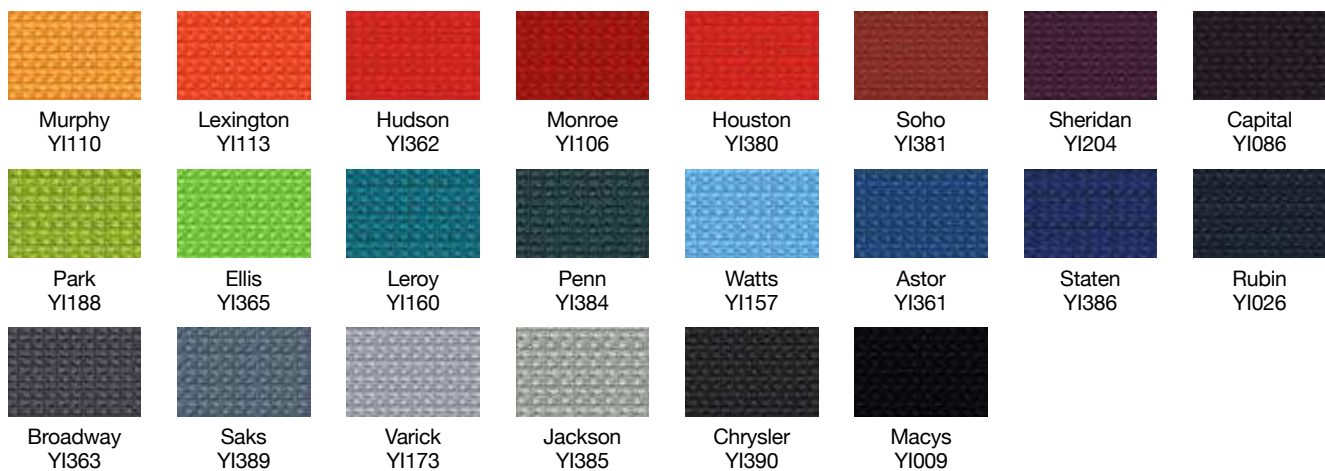

A selection of our most popular colour fabrics shown. For more colour options visit www.camirafabrics.com/contract
Swatches shown are for illustration only, colour may vary.

FABRIC SWATCHES

SCREENS

GROUP 1

CARA

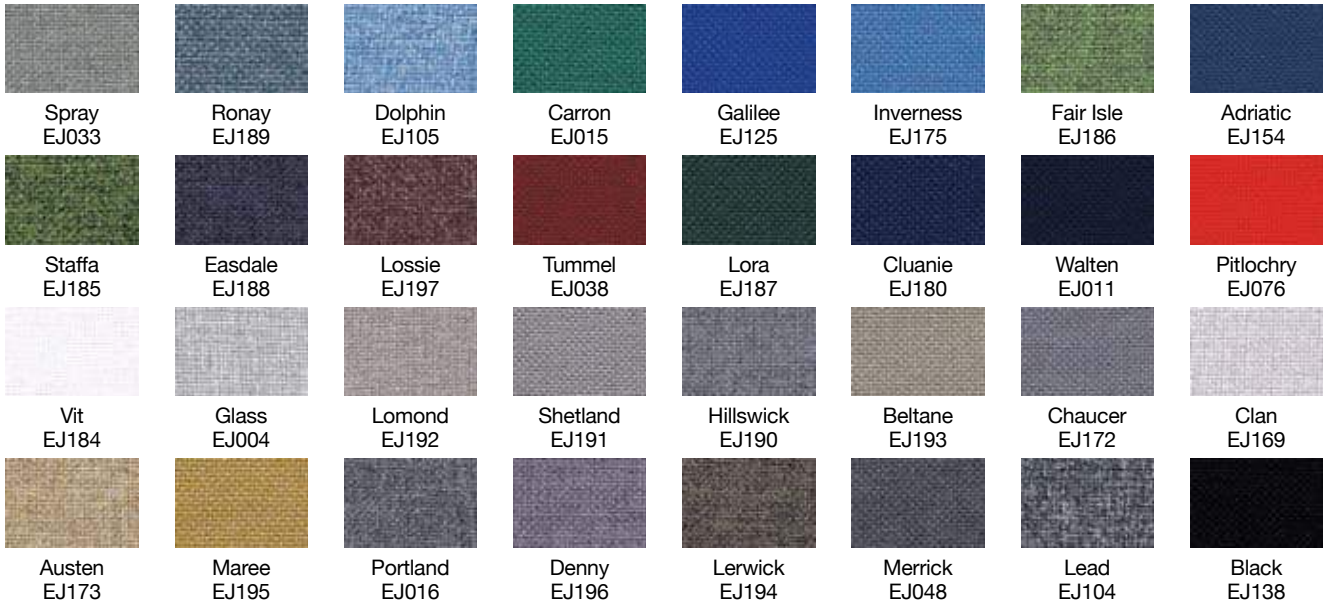

CARLOW

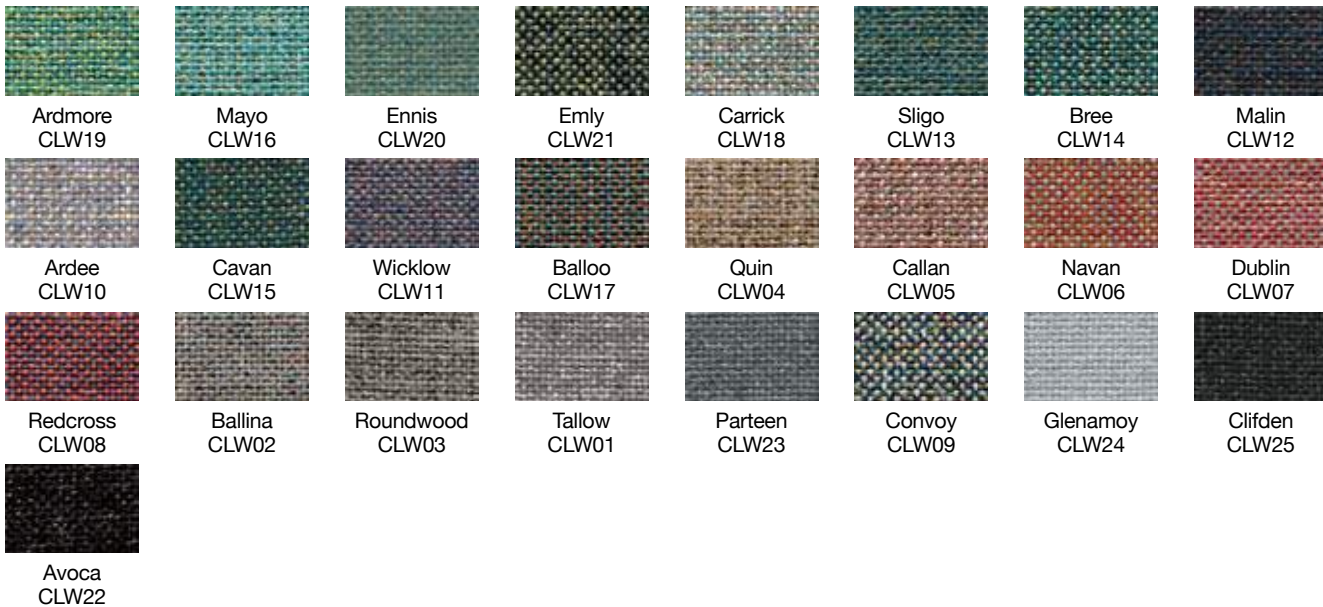

A selection of our most popular colour fabrics shown. For more colour options visit www.camirafabrics.com/contract
Swatches shown are for illustration only, colour may vary.

FABRIC SWATCHES

SCREENS

GROUP 2

LUCIA



STANDARD WAVE SCREEN

Shown in Cara Fair Isle
(Group 1)
page 181

A selection of our most popular colour fabrics shown. For more colour options visit www.camirafabrics.com/contract
Swatches shown are for illustration only, colour may vary.

DESK CONFIGURATIONS

CRESCENT DESK

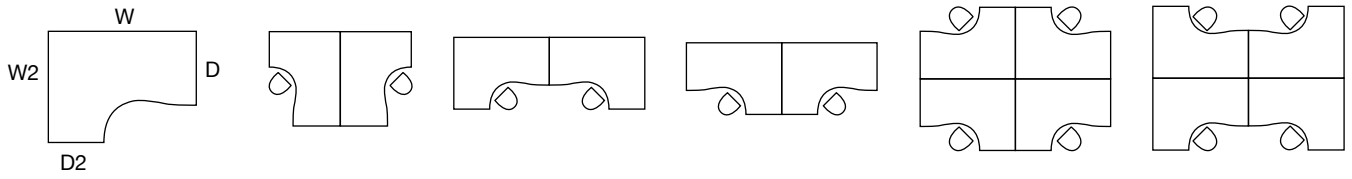

WAVE DESK

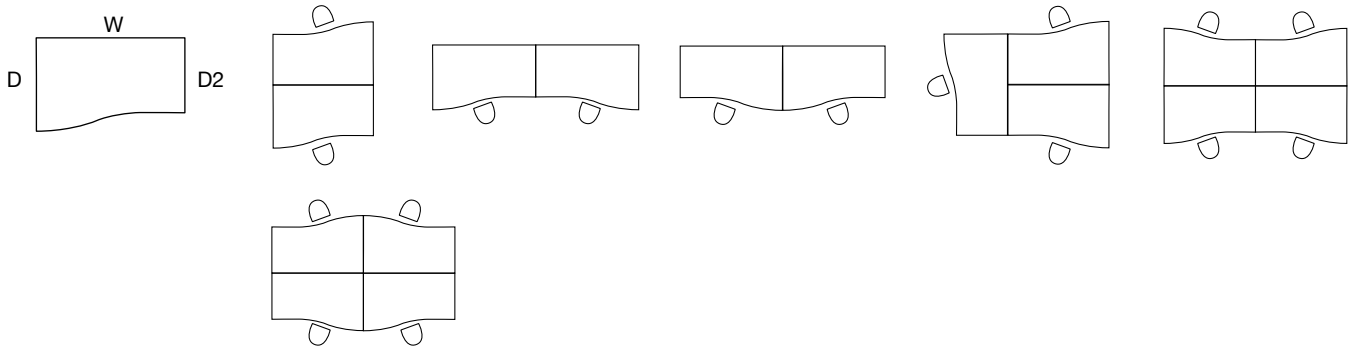

DOUBLE WAVE DESK

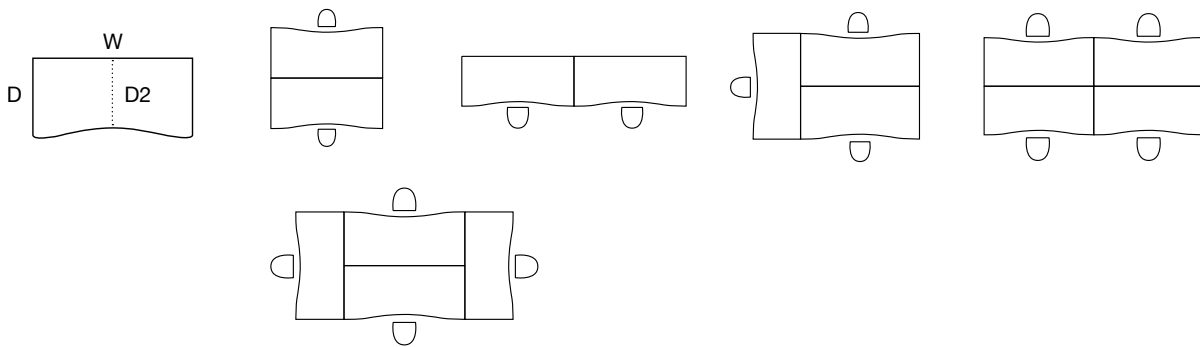

RECTANGULAR DESKS

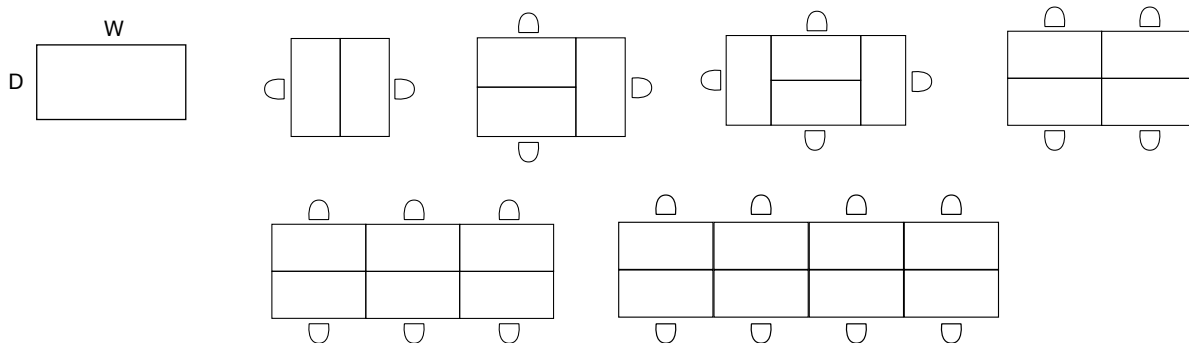

DESK CONFIGURATIONS

ATMOSPHERE DELTA DESK

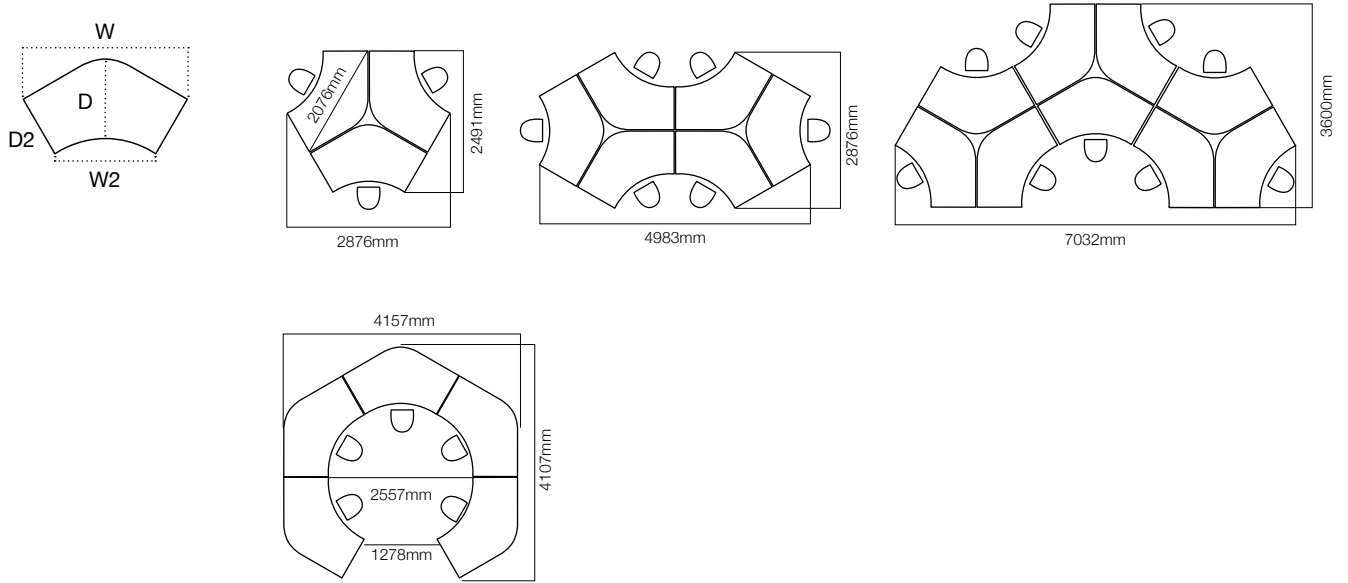

DUTY DELTA DESK

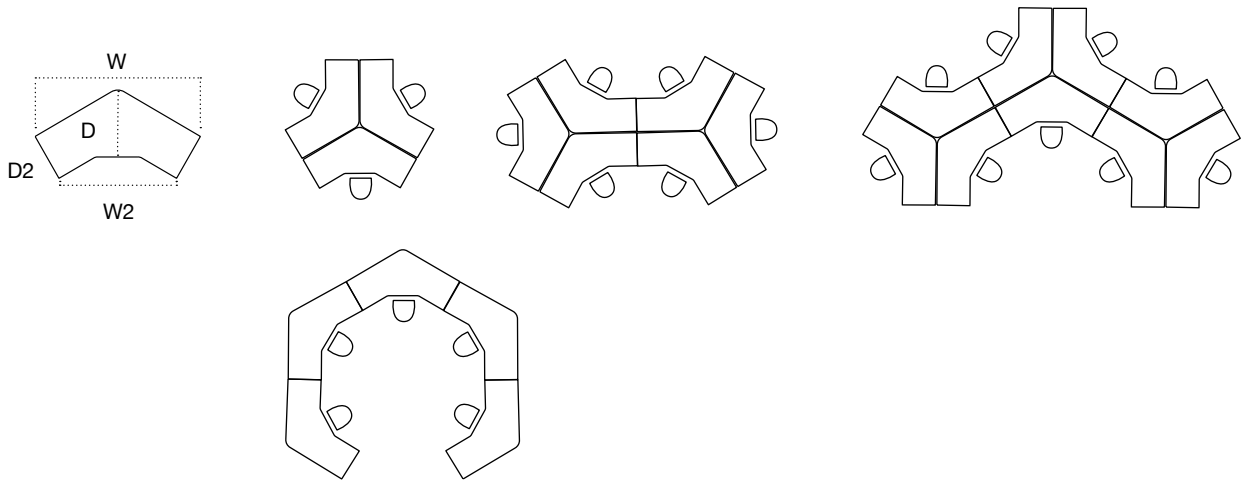

DUTY UNIVERSAL CRESCENT

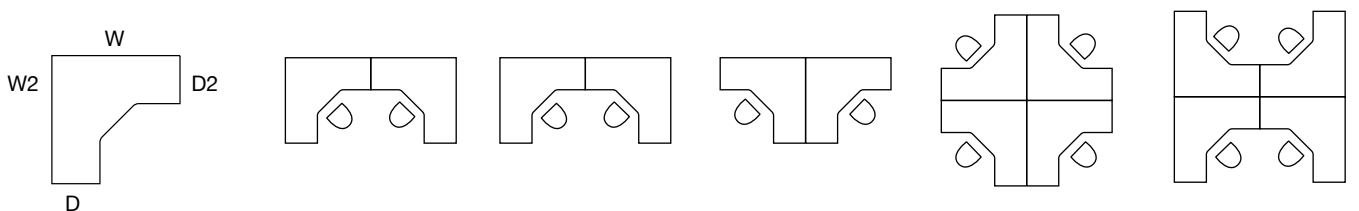

DESK CONFIGURATIONS

AURABENCH

A selection of configurations are displayed below. If you require a configuration that is not displayed, the bench system allows you to add additional desks to create your own combination. For example: add a Plus 2 to a set of 8 for a 10 desk configuration.

RECTANGULAR DESK, AURABENCH

600 / 800 Deep

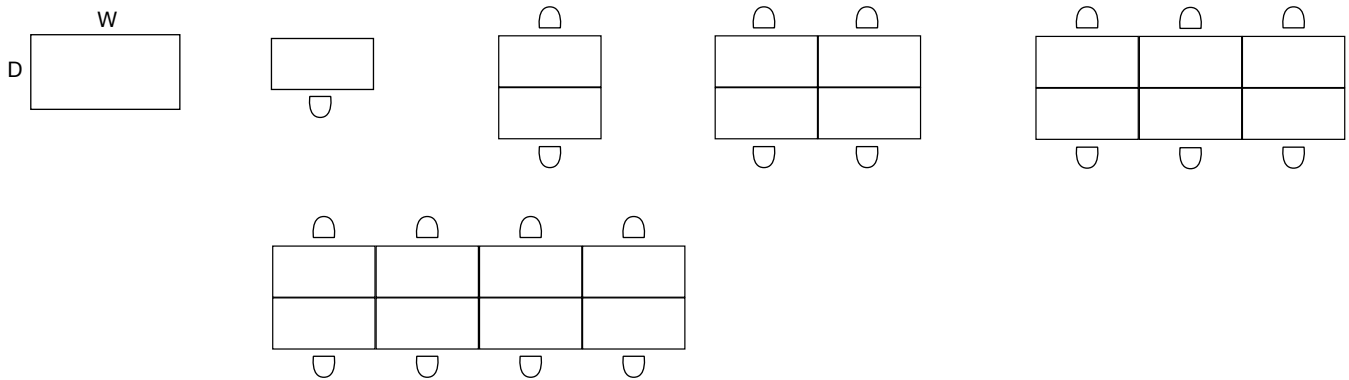

WAVE DESK, AURABENCH

600 / 800 Deep

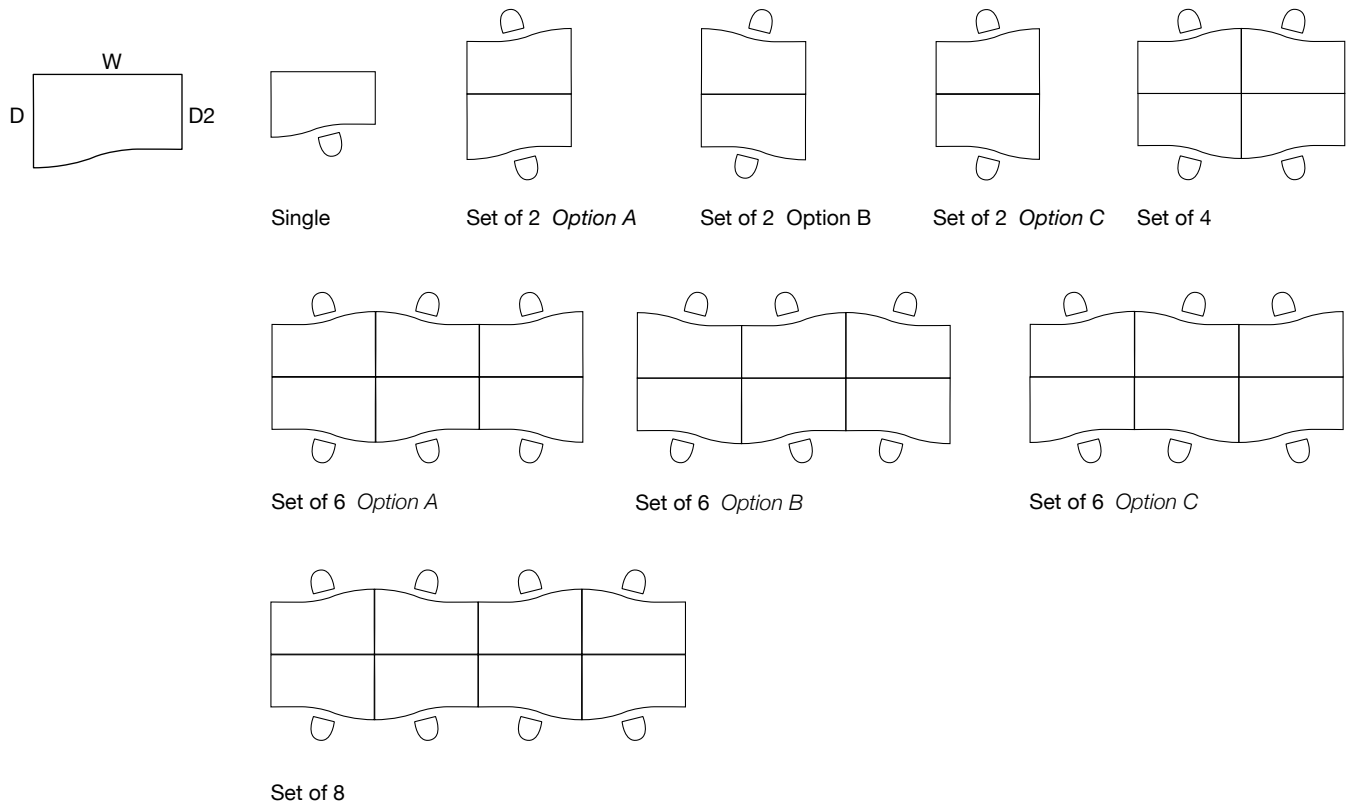
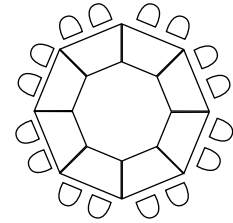
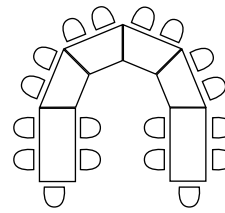
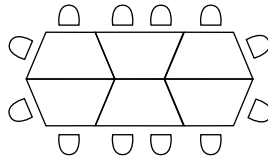
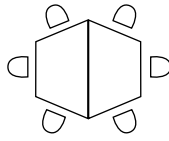
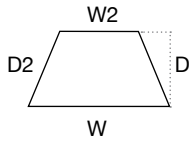
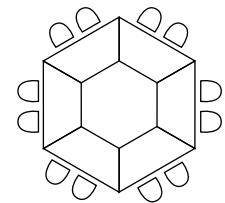
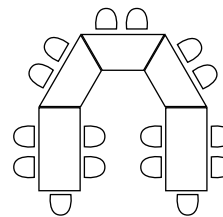
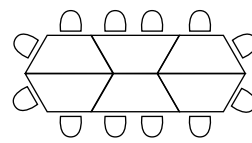
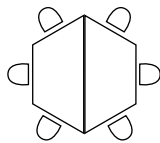
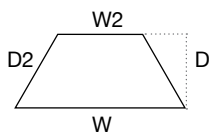

TABLE CONFIGURATIONS

TRAPEZOIDAL 22.5° TABLES



TRAPEZOIDAL 30° TABLES



SEMI CIRCULAR TABLES

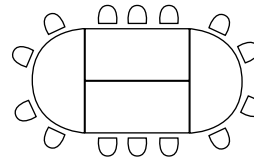
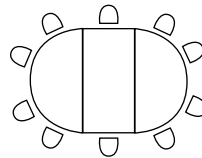
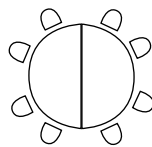
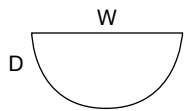

RECTANGULAR TABLES

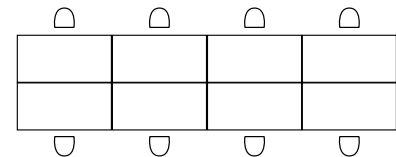
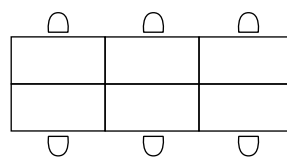
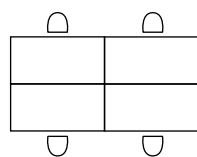
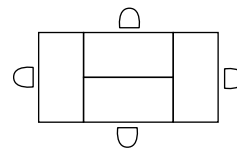
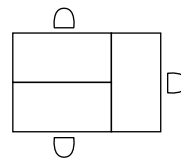
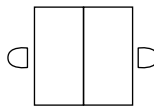
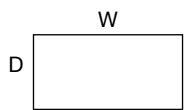

FEED YOUR DREAMS

Front cover features our new InMotion desks.
See pages 10 to 15.

Back cover features Sled tall tables pages 100 to 101,
shown with Lingwood high stools page 152.



LEE & PLUMPTON

HEAD OFFICE

Bunns Bank
Attleborough
Norfolk
NR17 1QD

T +44 (0) 1953 453830

F +44 (0) 1953 456349

E: sales@leeandplumpton.co.uk

leeandplumpton.co.uk



JOIN THE CONVERSATION



GUIDERRP October 2018

E&OE October 2018

Images featured within this brochure are for illustrative purposes and appearances may vary from those shown.

Due to our ongoing initiatives, Lee & Plumpton Ltd. reserve the right to change, modify or delete products at any time without notification.